

# NG/ND-Frames

## 320-1600A, 240-690V

### Contents

#### Series G NG-Frame

##### Digitrip 310+ Electronic Trip Unit types NGS, NGH, NGC, NGU

Page

Catalog Number Selection	3
Long Delay Response and Short Delay with Flat Response and Override (LSI, LSIG, ALSI, ALSIG)	TC01210010E . . . . . 4
Long Delay Response and Short Delay with I <sup>2</sup> T Response Curve and Override (LS, LSG)	TC01210011E . . . . . 5
Ground Fault Delay Response Curve (LSG, LSIG, ALSIG)	TC01210012E . . . . . 6
Maintenance Mode / Instantaneous Setting (ALSI, ALSIG)	TC01210016E . . . . . 7

##### Digitrip OPTIM 550 Trip Unit type NHH High Instantaneous

Long Delay I <sup>2</sup> T and Short Delay Flat	TC01207016E . . . . . 8
Long Delay I <sup>4</sup> T and Short Delay Flat	TC01207017E . . . . . 9
Instantaneous and Override	TC01207018E . . . . . 10

##### Digitrip 310 Electronic Trip Units

Eaton/Cutler-Hammer NG___T__W Electronic LD and SD with I <sup>2</sup> T Response	TC01209003E . . . . . 11
Eaton/Cutler-Hammer NG___T__W Electronic LD and SD with Flat Response	TC01209004E . . . . . 12
Eaton/Cutler-Hammer NG___T__W Electronic LD and SD with Flat Response (1600A)	TC01209006E . . . . . 13

#### Series C ND-Frame

Catalog Number Selection	14
--------------------------	----

##### NES Digitrip RMS 310 Electronic Trip Unit types ND, CND, HND, CHND, NDC, CNDC

I <sup>2</sup> T Ramp Short Time Delay	SC-5375-92A . . . . . 15
Adjustable Short Time Delay	SC-5376-92A . . . . . 16
Ground Fault Protection	SC-5377-92A . . . . . 17

##### Digitrip OPTIM 550 & 1050 Electronic Trip unit types ND, HND, NDC

Long Delay I <sup>2</sup> T, Short Delay I <sup>2</sup> T	SC-6331-96 . . . . . 18
Long Delay I <sup>2</sup> T, Short Delay Flat	SC-6332-96 . . . . . 19
Long Delay I <sup>4</sup> T, Short Delay Flat	SC-6333-96 . . . . . 20
Instantaneous and Override	SC-6334-96 . . . . . 21
Ground Fault Protection	SC-6335-96 . . . . . 22

**Note:**

The following curves meet the requirements of UL, CSA, IEC, CCC and CE.  
 The following circuit breakers are derived from Eaton, Westinghouse, or Cutler-Hammer history.

Time Current Curves are engineering reference documents for application and coordination purposes only.





### Catalog Number Selection

This information is presented only as an aid to understanding catalog numbers. It is not to be used to build catalog numbers for circuit breakers or trip units.

**Table 1. Series G N-Frame (320-1600A)**

<b>Frame</b> NG				<b>Performance</b>				<b>Amperes</b>		<b>Trip Unit</b>				<b>Rating</b>		<b>Terminations<sup>③</sup></b>		<b>Feature</b>				
				<b>600</b>	<b>480</b>	<b>415</b>	<b>240</b>	<b>080</b> = 800					<b>Blank</b> = 80% rated									
				<b>S</b>	25	50	50	85	<b>120</b> = 120					<b>C</b> = 100% rated								
				<b>H</b>	35	65	70	100	<b>125</b> = 1250 <sup>④</sup>					<b>Blank</b> = No feature								
				<b>C</b>	65	100	100	200	<b>160</b> = 1600 <sup>④</sup>					<b>B20</b> = High load alarm								
				<b>U</b> <sup>①</sup>	65	150	150	200					<b>B21</b> = Ground fault									
								<b>Poles</b>														
								3 = Three														
								4 = Four; neutral <sup>②</sup>														
								7 = Four; neutral <sup>②</sup>														
								9 = Four; neutral <sup>②</sup>														
								0/60/100% adjustable protection														

**Notes**

① 800A only.

② Neutral inn left pole on GN; right pole on NG.

③ Breakers do not ship with lugs.

④ IEC Only

Trip units are factory installable only.

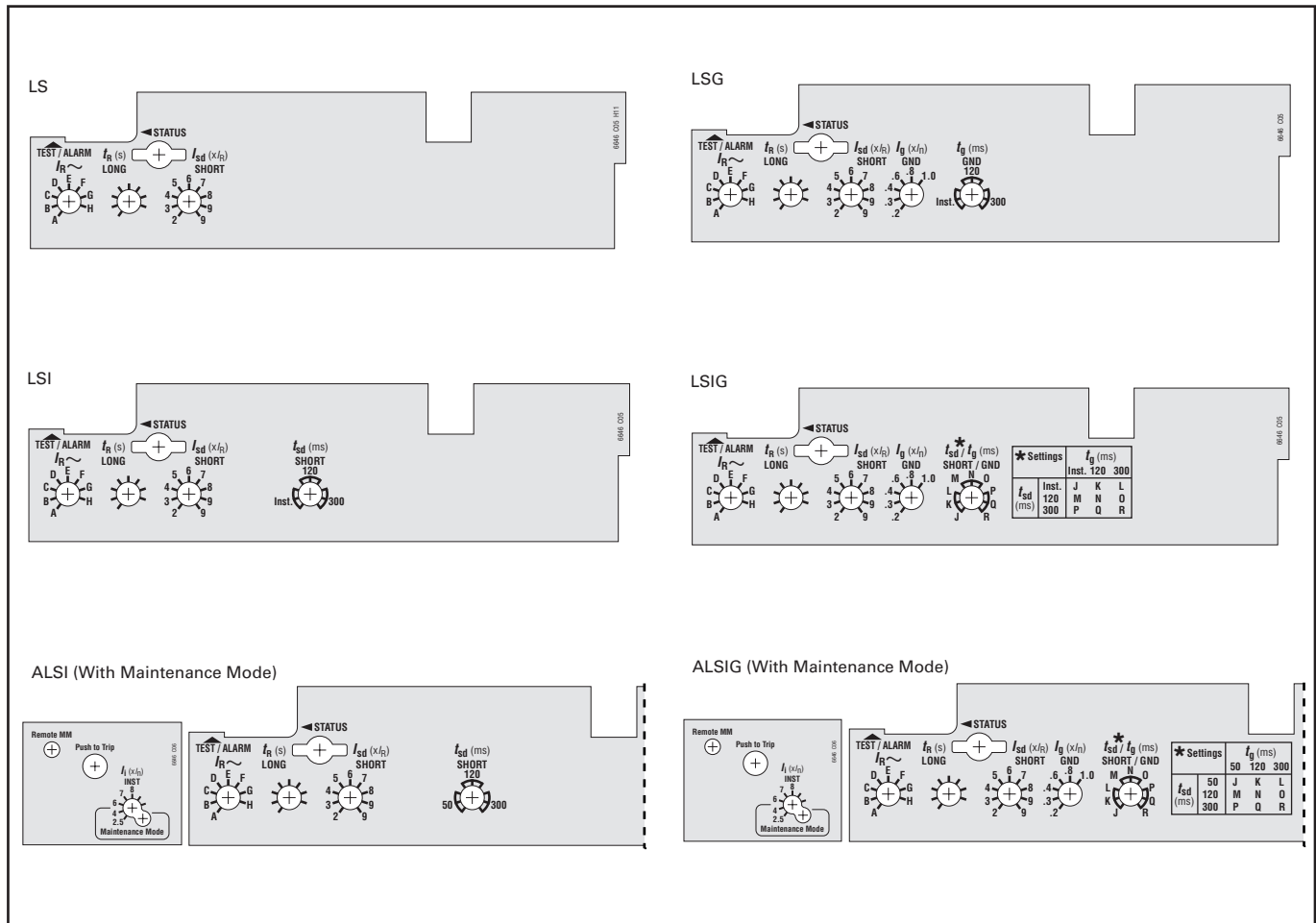



**Digitrip 310+ Circuit Breaker Time/Current Curves (Phase Current)**

**Series G N-Frame Circuit Breakers**

**Long Delay Response and Short Delay with Flat Response and Override**

**Catalog Types:** NGS, NGH, NGC, NGU, GNS, GNH, GNC, and GNU circuit breakers, three- and four-pole

**Trip Unit Type:** 32 (LSI), 36 (LSIG), 38 (ALSI), 39 (ALSIG)

Available Sensors (I <sub>f</sub> / I <sub>n</sub> )	Rated Amperes			
	800A	1200A	1250A	1600A
A	320A	500A	500A	630A
B	400A	600A	630A	630A
C	450A	630A	700A	700A
D	500A	700A	800A	800A
E	600A	800A	900A	900A
F	630A	900A	1000A	1000A
G	700A	1000A	1200A	1250A
H	800A	1200A	1250A	1600A

**Long Delay Time Settings +0% / -30% (seconds)**

	800A	1200A	1250A	1600A
800A	2	4	6	8
1200A	2	4	7	10
1250A	2	4	6	8
1600A	2	4	7	10

**Notes:**

- Curve accuracy applies from -20°C to +55°C ambient. For possible continuous ampere derating for ambient above 40°C, refer to Eaton. Temperatures above +85°C cause an over-temperature protection trip.
- Application frequency is 50/60 Hz.
- There is a memory effect that can act to shorten the Long Delay. If the breaker trips on a Long Delay overload and is quickly reset, the memory capacitor will still have charge and a subsequent overload will cause the breaker to trip in a shorter time than normal. The amount of time delay reduction is inverse to the amount of time that has elapsed since the previous overload. Approximately five minutes is required between overloads to completely reset memory.
- The right portion of the curve is determined by the interrupting rating of the circuit breaker.
- The left portion of the curve is shown as a multiple of the Long Delay Setting. (Long Delay Pickup = 115% of I<sub>r</sub>). Range is 110–120%.
- Total clearing times shown include the response times of the trip unit, the breaker opening, and the interruption of the current.
- The Short Delay Pickup has nine settings/positions, 2–8; the last two switch positions are the same: 9X.
- For high fault current levels, an additional fixed instantaneous hardware override is provided to trip the breaker at 14400A. Instantaneous tolerance is +/- 20%. For the 1600A frame only, if I<sub>r</sub> is set to the maximum (position H) and SDPU is set to the maximum (position 9), then the SDPU setting and the Instantaneous Override are set to the same value. The Instantaneous Override has precedence over SDPU. Therefore, the breaker will trip on Instantaneous Override.
- Maximum clearing time when using zone selective interlocking is 62ms.

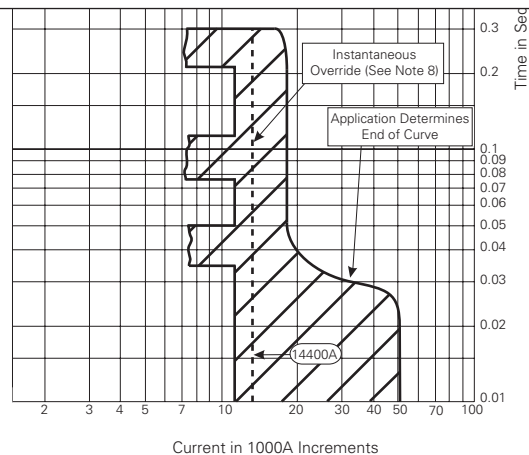
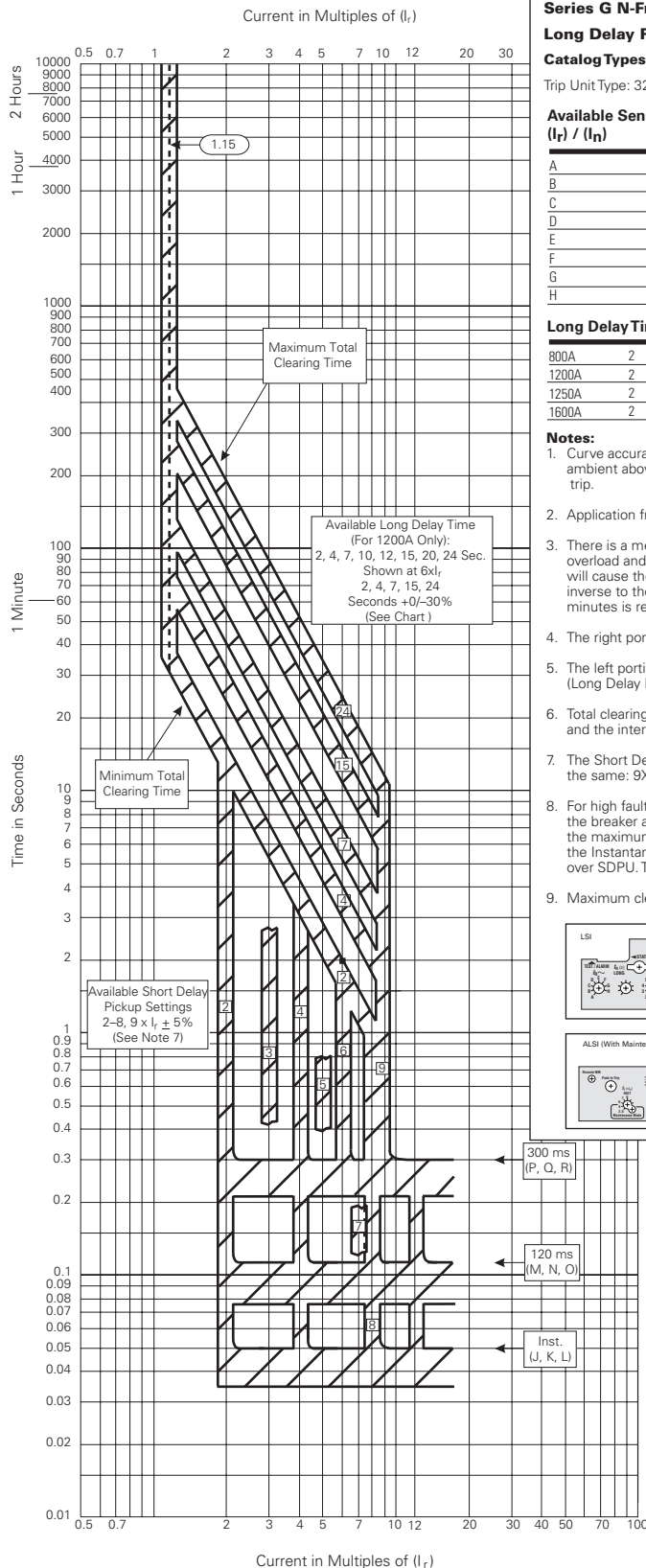
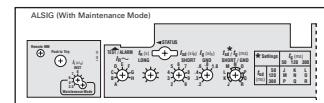
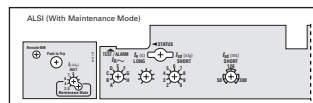
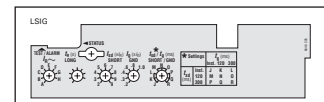
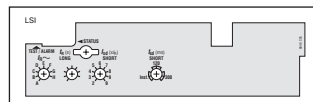

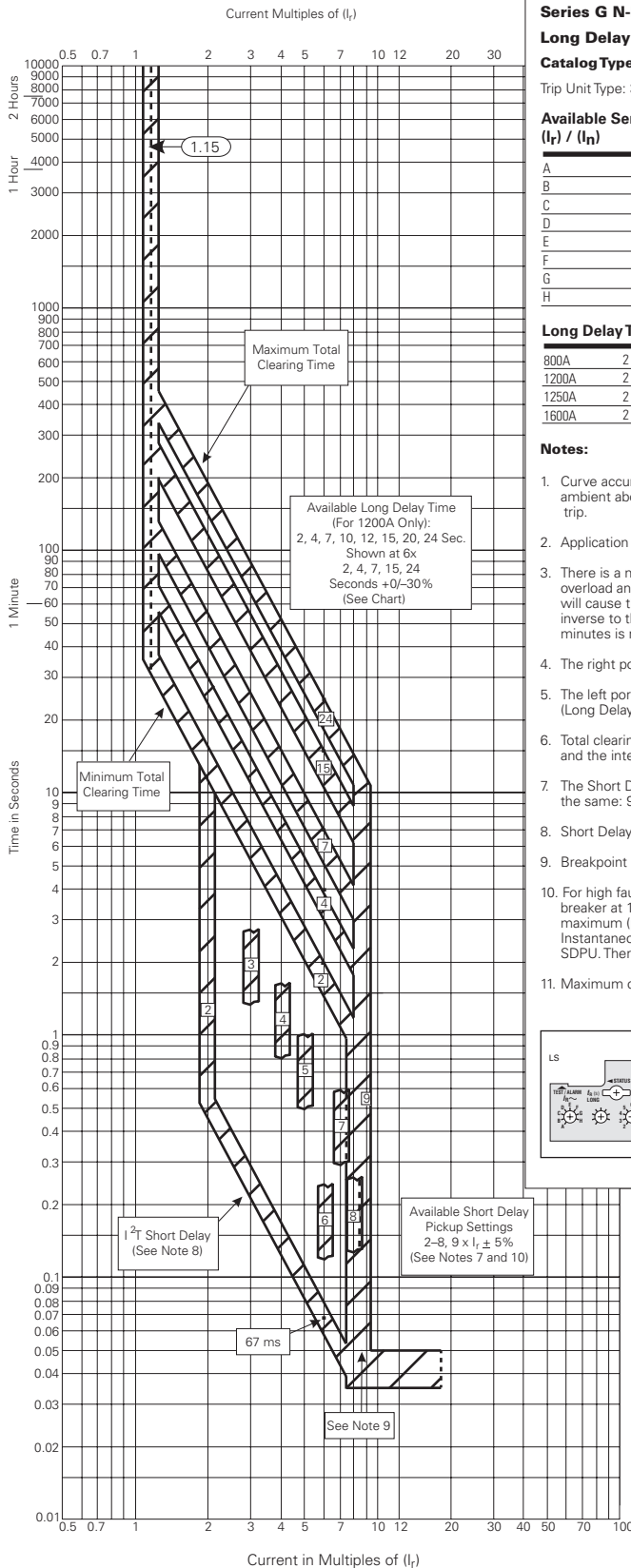

**Digitrip 310+ Circuit Breaker Time/Current Curves (Phase Current)**

**Series G N-Frame Circuit Breakers**

**Long Delay Response and Short Delay with  $I^2T$  Response Curve and Override**

**Catalog Types:** NGS, NGH, NGC, NGU, GNS, GNH, GNC, and GNU circuit breakers, three- and four-pole

Trip Unit Type: 33 (LS), 35 (LSG)

**Available Sensors ( $I_r$ ) / ( $I_n$ )**

	Rated Amperes			
	800A	1200A	1250A	1600A
A	320A	500A	500A	630A
B	400A	600A	630A	630A
C	450A	630A	700A	700A
D	500A	700A	800A	800A
E	600A	800A	900A	900A
F	630A	900A	1000A	1000A
G	700A	1000A	1200A	1250A
H	800A	1200A	1250A	1600A

**Long Delay Time Settings +0% / -30% (seconds)**

	2	4	6	8	10	12	14	14
800A	2	4	6	8	10	12	14	14
1200A	2	4	7	10	12	15	20	24
1250A	2	4	6	8	10	12	14	14
1600A	2	4	7	10	12	15	20	20

**Notes:**

- Curve accuracy applies from -20°C to +55°C ambient. For possible continuous ampere derating for ambient above 40°C, refer to Eaton. Temperatures above +85°C cause an over-temperature protection trip.
- Application frequency is 50/60 Hz.
- There is a memory effect that can act to shorten the Long Delay. If the breaker trips on a Long Delay overload and is quickly reset, the memory capacitor will still have charge and a subsequent overload will cause the breaker to trip in a shorter time than normal. The amount of time delay reduction is inverse to the amount of time that has elapsed since the previous overload. Approximately five minutes is required between overloads to completely reset memory.
- The right portion of the curve is determined by the interrupting rating of the circuit breaker.
- The left portion of the curve is shown as a multiple of the Long Delay Setting. (Long Delay Pickup = 115% of  $I_r$ ). Range is 110-120%.
- Total clearing times shown include the response times of the trip unit, the breaker opening, and the interruption of the current.
- The Short Delay Pickup has nine settings/positions, 2-8; the last two switch positions are the same: 9X.
- Short Delay  $I^2T$  band has a tolerance of +15%.
- Breakpoint back to FLAT response occurs @ 8x  $I_r$  for upper line of the  $I^2T$  curve.
- For high fault current levels, an additional fixed instantaneous hardware override is provided to trip the breaker at 14400A. Instantaneous tolerance is +/- 20%. For the 1600A frame only, if  $I_r$  is set to the maximum (position H) and SDPU is set to the maximum (position 9), then the SDPU setting and the Instantaneous Override are set to the same value. The Instantaneous Override has precedence over SDPU. Therefore, the breaker will trip on Instantaneous Override.
- Maximum clearing time when using zone selective interlocking is 62ms.

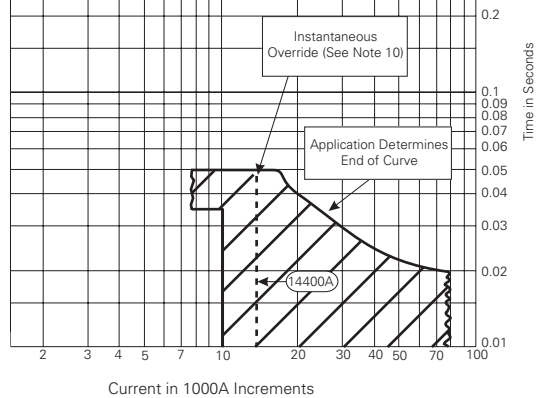
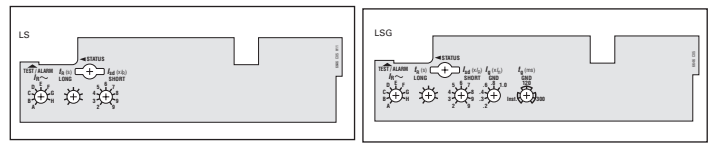

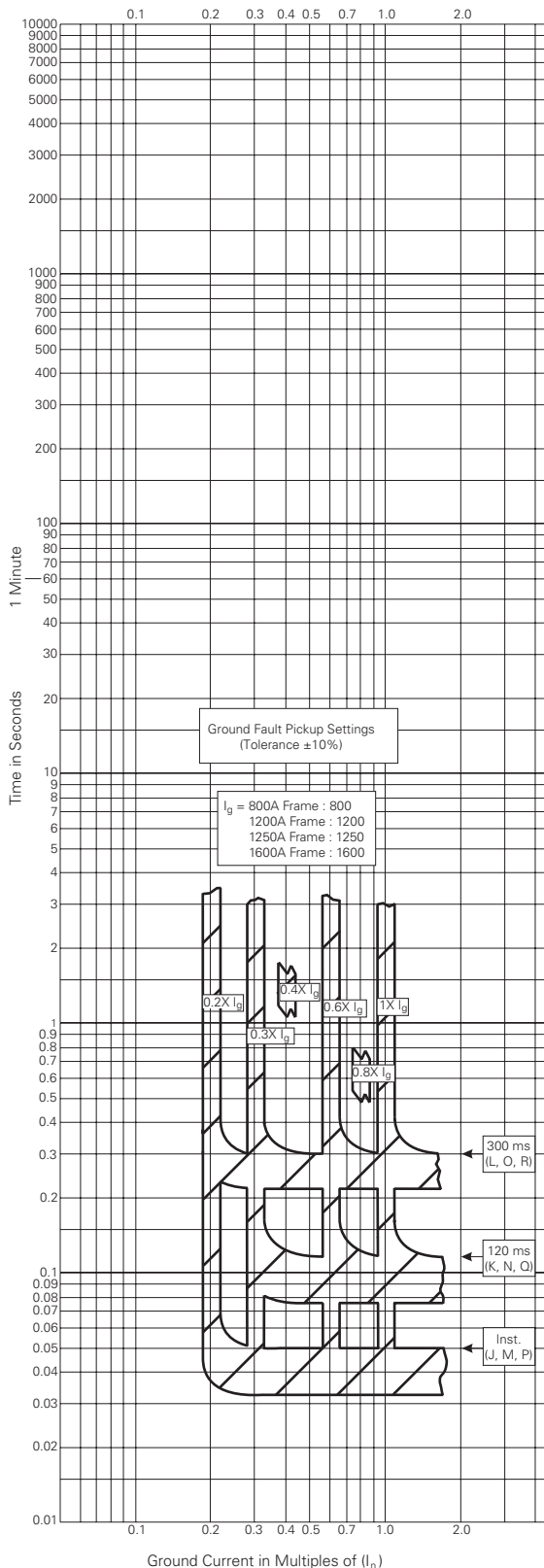

**Digitrip 310+ Circuit Breaker Time/Current Curves (Ground Current)**  
**Series G N-Frame Circuit Breakers**  
**Ground Fault Delay Response Curve**

**Catalog Types:** NGS, NGH, NGC, NGU, GNS, GNH, GNC, and GNU circuit breakers,  
three- and four-pole  
Trip Unit Type: 35 (LSG), 36 (LSIG), 39 (ALSIG)

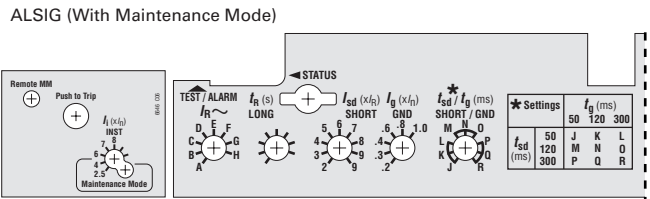
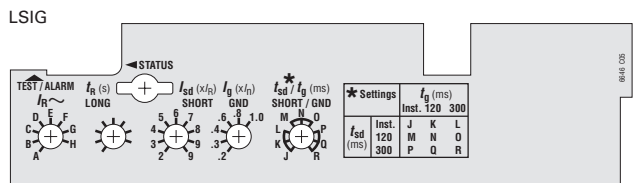
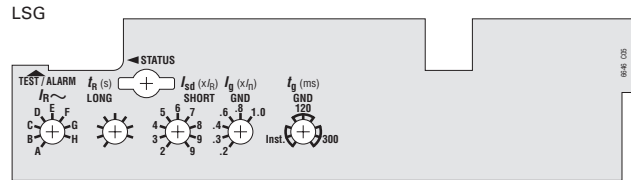

Note: Refer to table below for variations.

SD/ GF Delay Settings Table

* Settings	$t_g$ (ms)		
	Inst. 120	300	
$t_{sd}$ (ms)	J	K	L
	M	N	O
	P	Q	R

**Ground Fault Delay Response Notes:**

1. Curve accuracy applies from -20°C to +55°C ambient. For possible continuous ampere derating for ambient above 40°C, refer to Eaton. Temperatures about +85°C cause an overtemperature protection trip.
2. Application frequency is 50/60 Hz.
3. Trip units are suitable for functional field testing with test kit style # 70C1056G52.
4. For LD response and SD with flat responses curve, see TC01210010E.
5. For LD responses and SD with  $I^2T$  response curve, see TC01210011E.
6. For testing information, please contact Eaton.



**Digitrip 310+ Circuit Breaker Time/Current Curves**

**Maintenance Mode/Instantaneous Setting**

**Series G N-Frame Trip Unit Nameplates**

Trip Unit Type: 38 (ALSI), 39 (ALSIG)

**ALSI (With Maintenance Mode)**

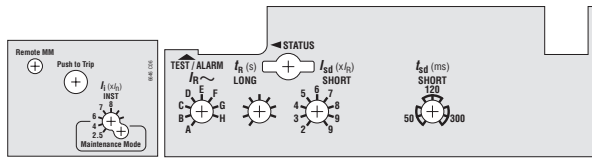

**ALSIG (With Maintenance Mode)**

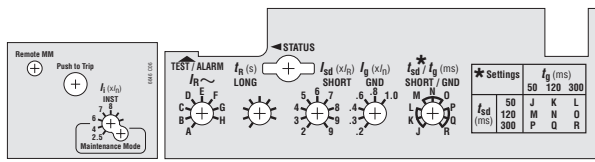

**Notes:**

1. The maintenance mode feature must be ENABLED for these curves to apply. The LED indicator is blue when in maintenance mode.
2. The end of the curve is determined by the interrupting rating of the circuit breaker.
3. Total clearing times shown include the response times of the trip unit, the breaker opening, and the interruption of the current.
4. Available pickup settings ( $\times I_n$ ) (tolerance is  $\pm 15\%$ ) 2.5, 4, 6, 7, 8, 10.
5. The Maintenance Mode consists of the two lowest settings of the INST switch: 2.5x and 4.0x.
6. The Remote Maintenance Mode is enabled by applying 24 VDC to the two wire cable that exists the left side of the breaker. The wires are color coded as follows: Yellow = +24 V and Black = common ground. A blue colored LED, on the left side of the breaker is the Maintenance Mode section of the trip unit, will light. The lighted blue LED indicates that the lowest setting of the Maintenance Mode is enabled. This setting corresponds to 2.5x of In. Turning the adjustable switch on the trip unit has no affect on either the Maintenance Mode or the INST Mode settings while the blue LED is lit. In addition to the blue colored LED, a relay contact (C, NO) is available. The wires for this contact exit the left hand side of the breaker and are color coded as follows: Blue = C, and Red = NO.
7. Contact Eaton for additional information.

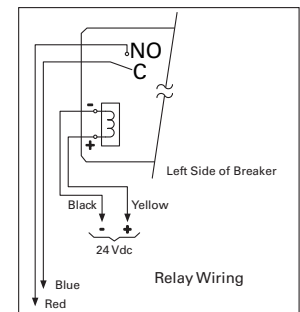

Maintenance Mode Trip

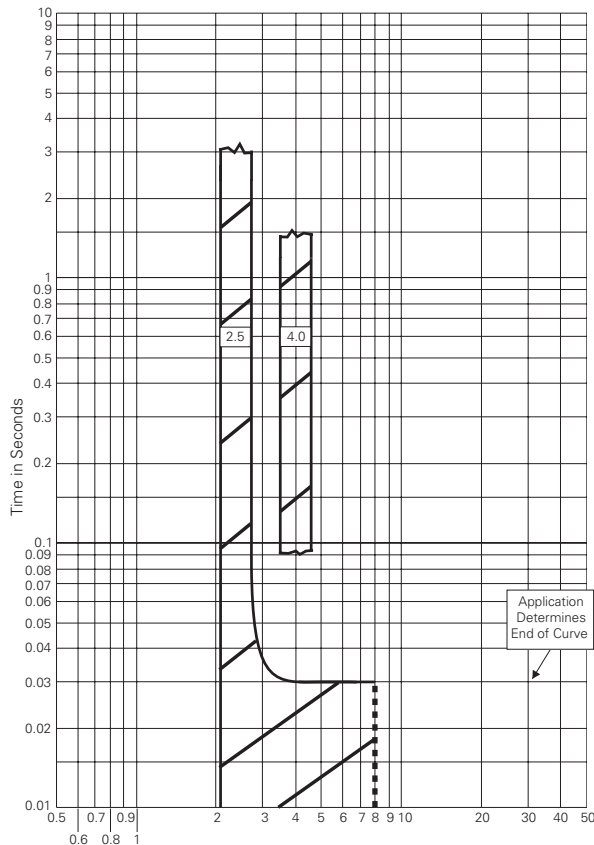

Instantaneous Mode Trip

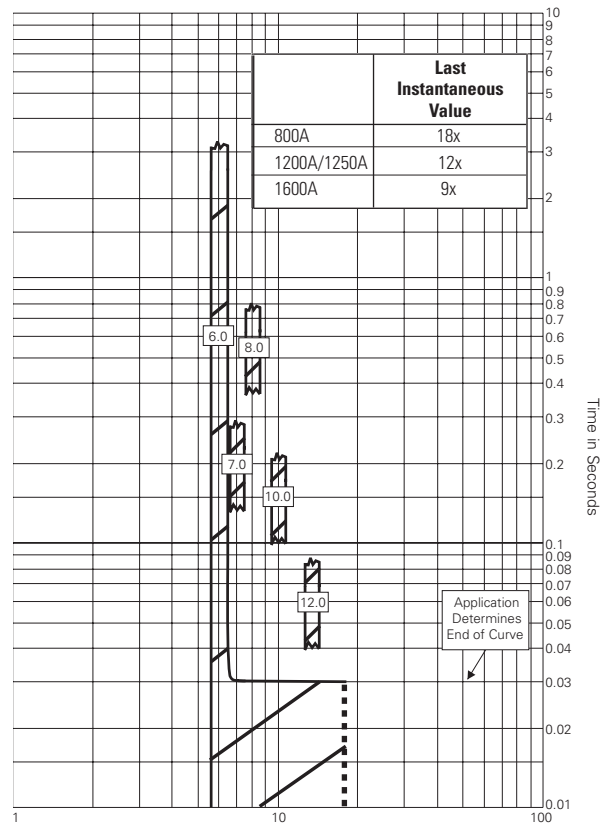

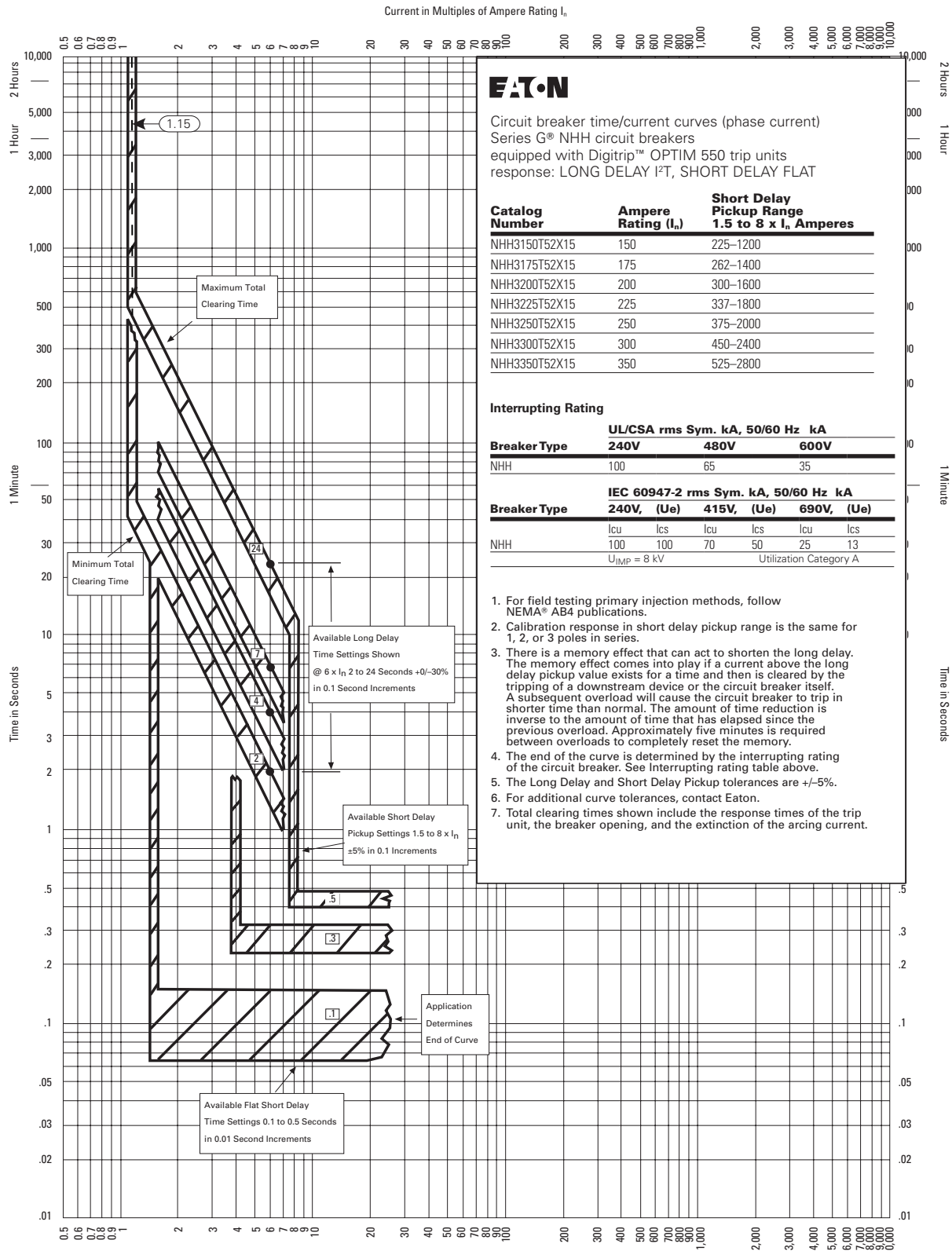

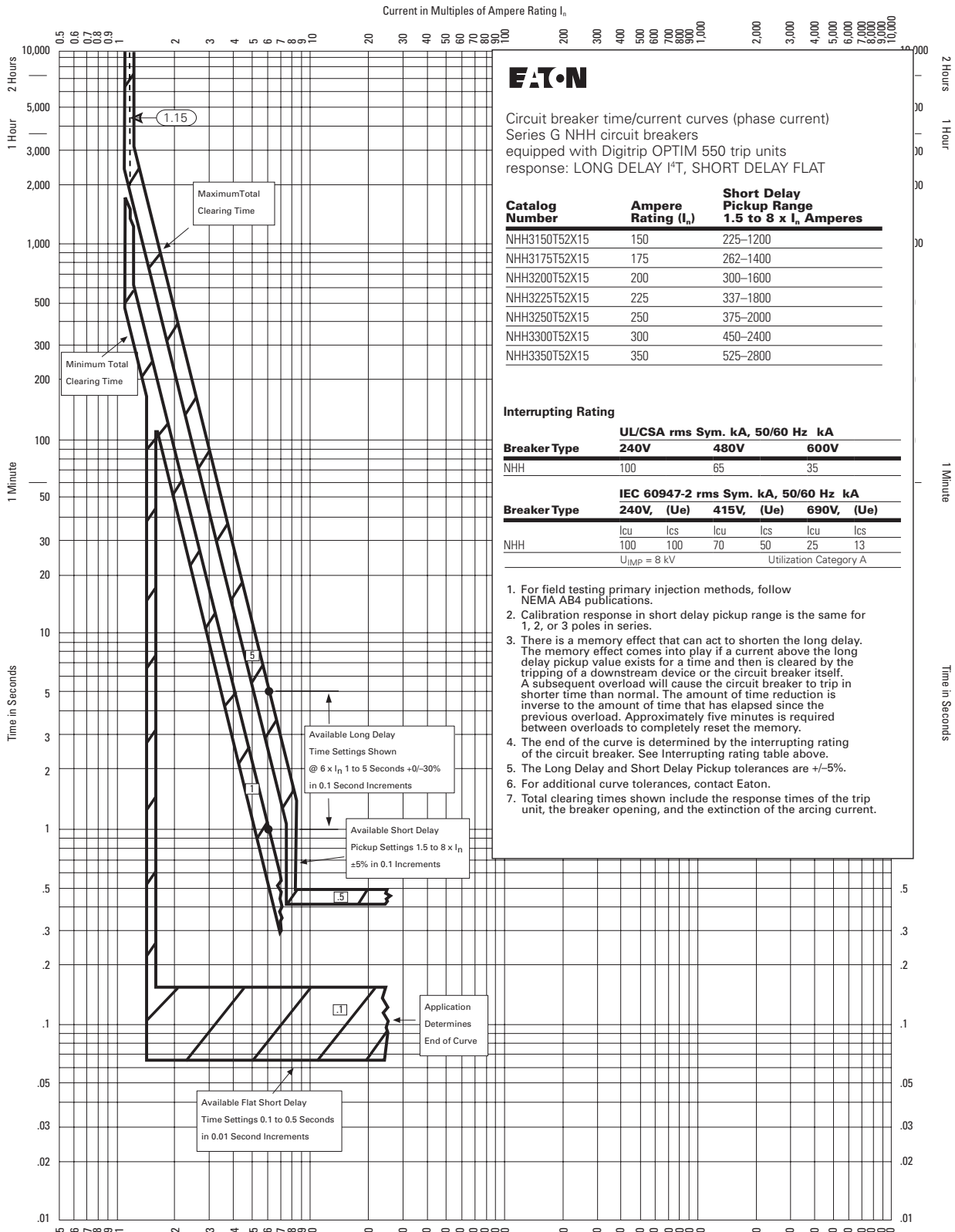

Circuit breaker time/current curves (phase current)  
 Series G NHH circuit breakers  
 equipped with Digitrip OPTIM 550 trip units  
 response: LONG DELAY I<sup>2</sup>T, SHORT DELAY FLAT

Catalog Number	Ampere Rating (I <sub>n</sub> )	Short Delay Pickup Range 1.5 to 8 x I <sub>n</sub> Amperes
NHH3150T52X15	150	225–1200
NHH3175T52X15	175	262–1400
NHH3200T52X15	200	300–1600
NHH3225T52X15	225	337–1800
NHH3250T52X15	250	375–2000
NHH3300T52X15	300	450–2400
NHH3350T52X15	350	525–2800

**Interrupting Rating**

Breaker Type	UL/CSA rms Sym. kA, 50/60 Hz kA		
	240V	480V	600V
NHH	100	65	35

Breaker Type	IEC 60947-2 rms Sym. kA, 50/60 Hz kA					
	240V, (U <sub>e</sub> )		415V, (U <sub>e</sub> )		690V, (U <sub>e</sub> )	
	I <sub>cu</sub>	I <sub>cs</sub>	I <sub>cu</sub>	I <sub>cs</sub>	I <sub>cu</sub>	I <sub>cs</sub>
NHH	100	100	70	50	25	13

U<sub>IMP</sub> = 8 kV Utilization Category A

- For field testing primary injection methods, follow NEMA AB4 publications.
- Calibration response in short delay pickup range is the same for 1, 2, or 3 poles in series.
- There is a memory effect that can act to shorten the long delay. The memory effect comes into play if a current above the long delay pickup value exists for a time and then is cleared by the tripping of a downstream device or the circuit breaker itself. A subsequent overload will cause the circuit breaker to trip in shorter time than normal. The amount of time reduction is inverse to the amount of time that has elapsed since the previous overload. Approximately five minutes is required between overloads to completely reset the memory.
- The end of the curve is determined by the interrupting rating of the circuit breaker. See Interrupting rating table above.
- The Long Delay and Short Delay Pickup tolerances are +/-5%.
- For additional curve tolerances, contact Eaton.
- Total clearing times shown include the response times of the trip unit, the breaker opening, and the extinction of the arcing current.

Available Long Delay  
 Time Settings Shown  
 @ 6 x I<sub>n</sub> 1 to 5 Seconds +/-30%  
 in 0.1 Second Increments

Available Short Delay  
 Pickup Settings 1.5 to 8 x I<sub>n</sub>  
 ±5% in 0.1 Increments

Application  
 Determines  
 End of Curve

Available Flat Short Delay  
 Time Settings 0.1 to 0.5 Seconds  
 in 0.01 Second Increments

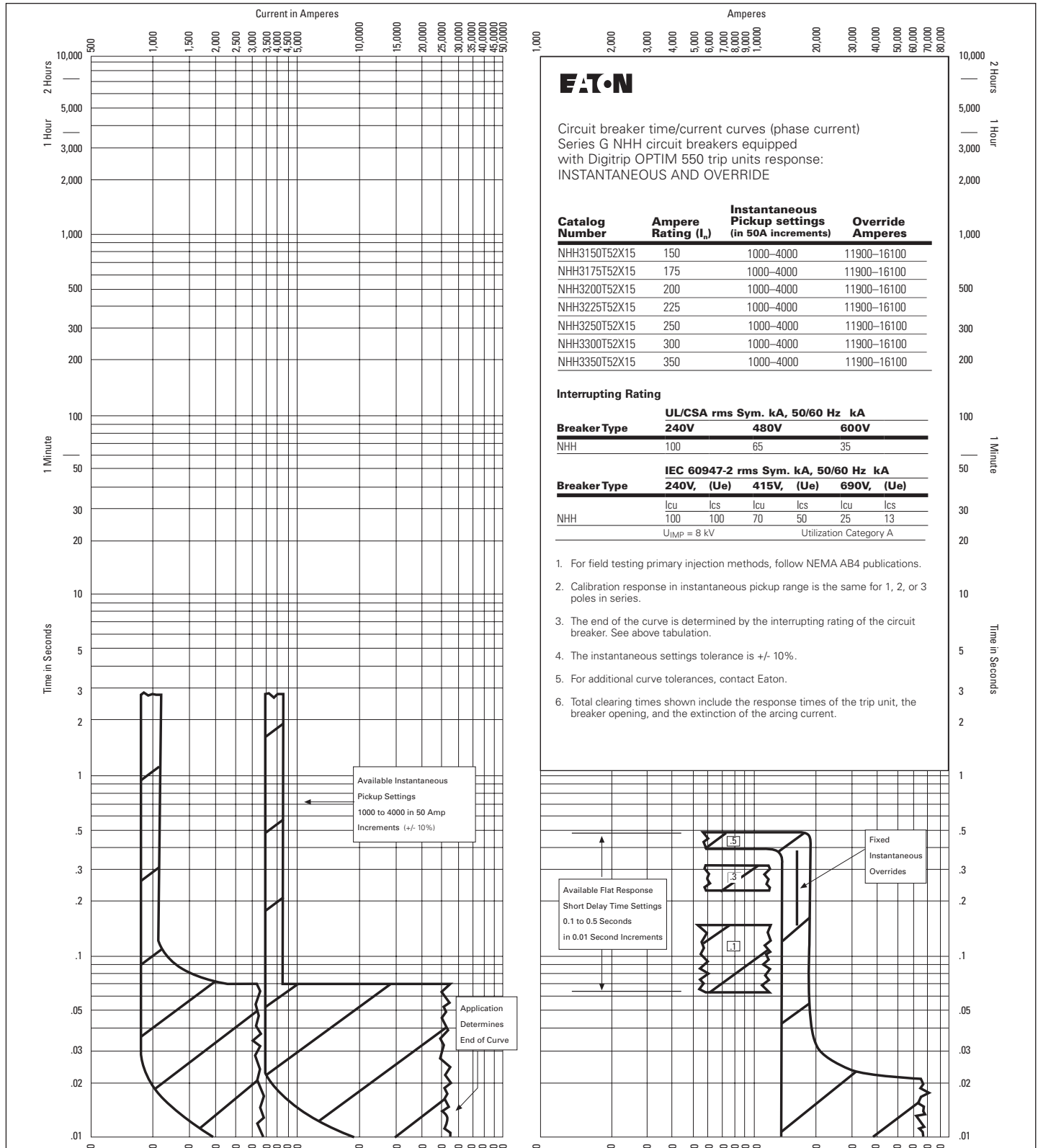

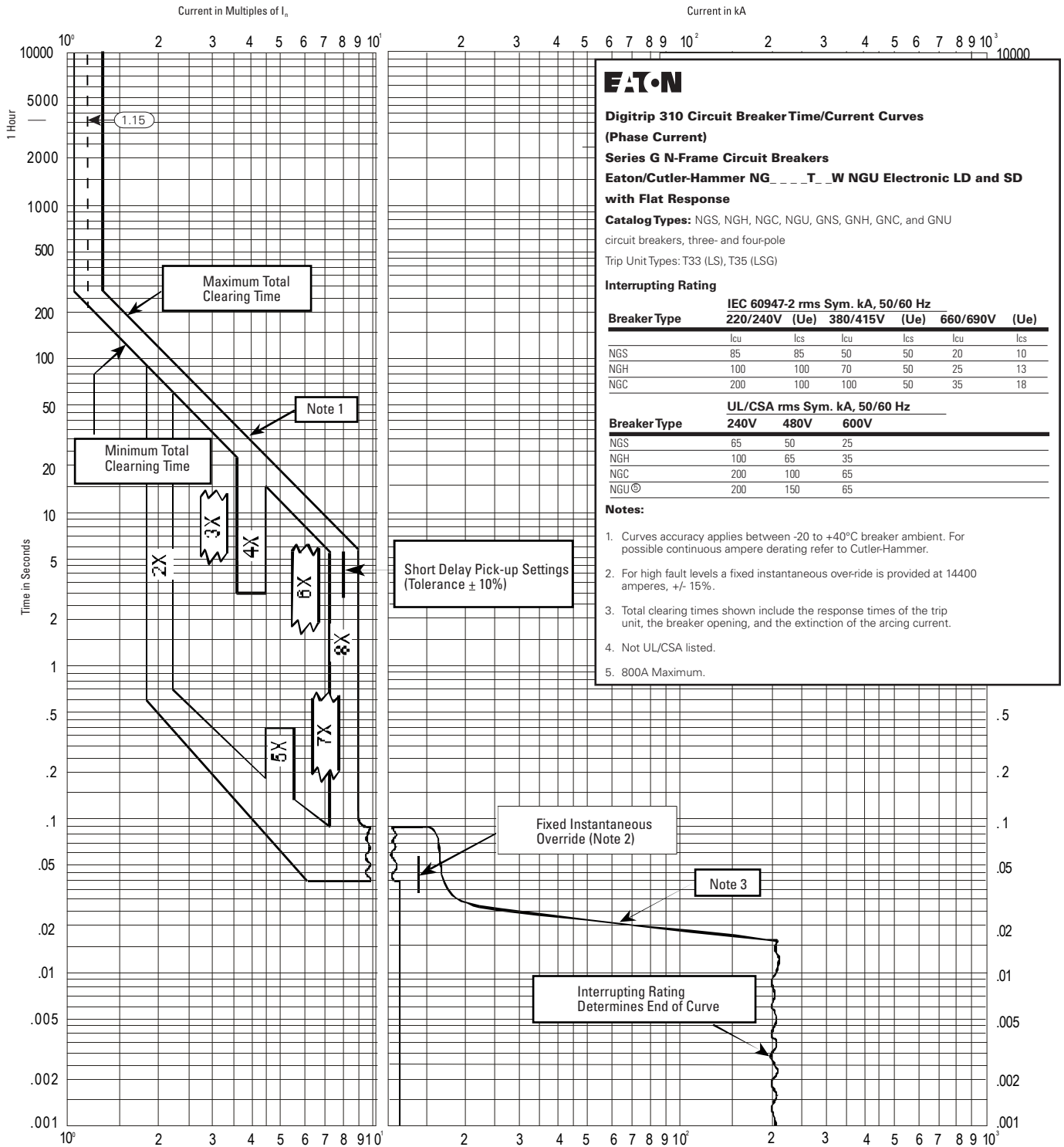

**Digitrip 310 Circuit Breaker Time/Current Curves (Phase Current)**

**Series G N-Frame Circuit Breakers**

**Eaton/Cutler-Hammer NG...T...W NGU Electronic LD and SD with Flat Response**

**Catalog Types:** NGS, NGH, NGC, NGU, GNS, GNH, GNC, and GNU

circuit breakers, three- and four-pole

Trip Unit Types: T33 (LS), T35 (LSG)

**Interrupting Rating**

**IEC 60947-2 rms Sym. kA, 50/60 Hz**

Breaker Type	220/240V (Ue)		380/415V (Ue)		660/690V (Ue)	
	Icu	Ics	Icu	Ics	Icu	Ics
NGS	85	85	50	50	20	10
NGH	100	100	70	50	25	13
NGC	200	100	100	50	35	18

**UL/CSA rms Sym. kA, 50/60 Hz**

Breaker Type	240V			480V			600V		
	Icu	Ics	Icu	Icu	Ics	Icu	Ics	Icu	Ics
NGS	65	50	25						
NGH	100	65	35						
NGC	200	100	65						
NGU	200	150	65						

**Notes:**

- Curves accuracy applies between -20 to +40°C breaker ambient. For possible continuous ampere derating refer to Cutler-Hammer.
- For high fault levels a fixed instantaneous override is provided at 14400 amperes, +/- 15%.
- Total clearing times shown include the response times of the trip unit, the breaker opening, and the extinction of the arcing current.
- Not UL/CSA listed.
- 800A Maximum.

**1250 & 1200 Ampere Trip Unit Rating Plug**

Ampere Rating (I <sub>n</sub> )	Type	Pick-up Range Amperes
1250	Fixed	2500-10000 ④
1200	Fixed	2400-9600
1000	Fixed	2000-8000
900	Fixed	1800-7200
800	Fixed	1600-6400
700	Fixed	1400-5600
630	Fixed	1260-5040 ④
600	Fixed	1200-4800
600,800,1000,1200	Adjustable	1200-9600

**800 Ampere Trip Unit Rating Plug**

Ampere Rating (I <sub>n</sub> )	Type	Pick-up Range Amperes
800	Fixed	1600-6400
700	Fixed	1400-5600
630	Fixed	1260-5040 ④
600	Fixed	1200-4800
550	Fixed	1100-4400
500	Fixed	1000-4000
450	Fixed	900-3600
400	Fixed	800-3200
400,500,600,800	Adjustable	800-6400

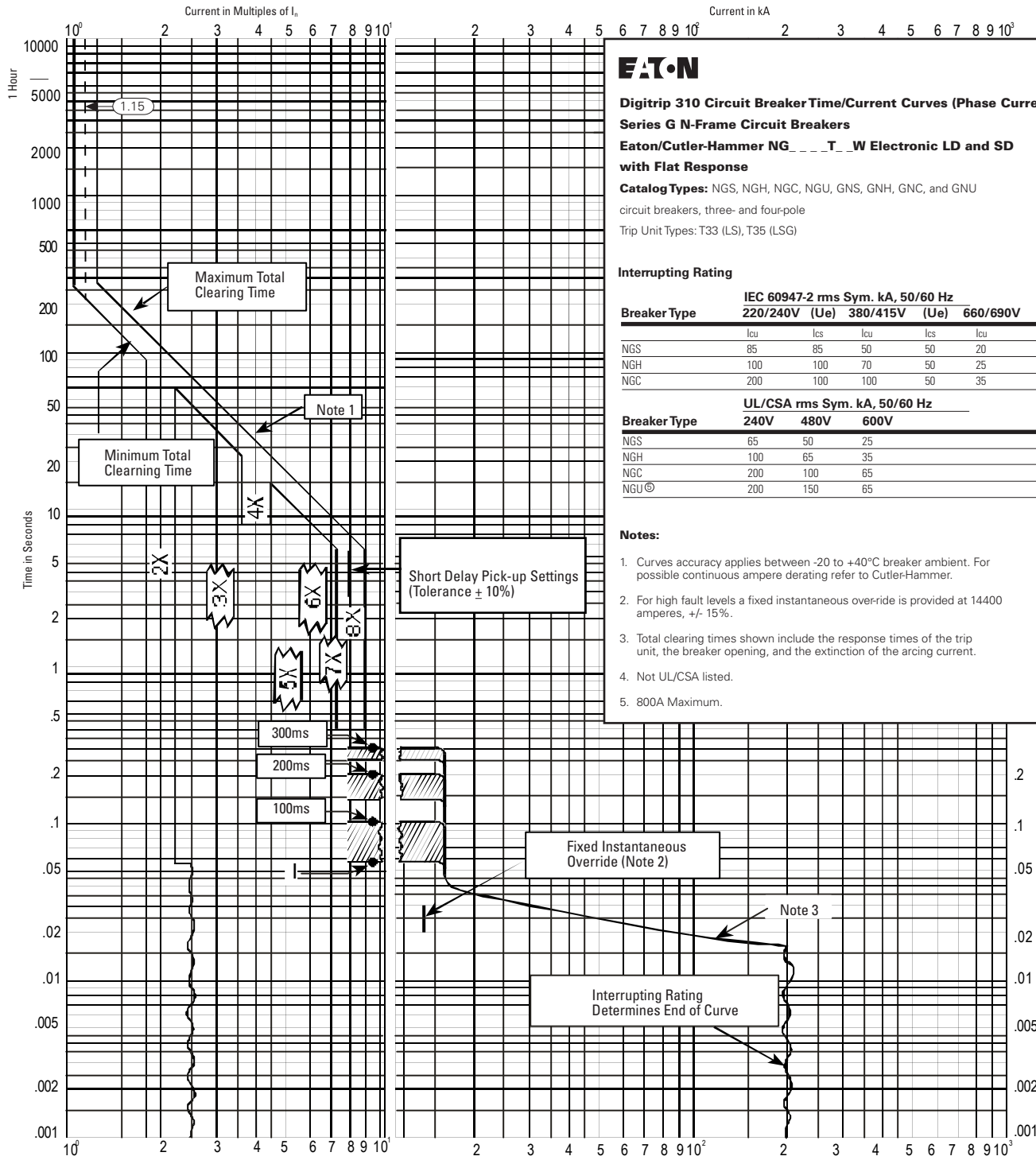

**Digitrip 310 Circuit Breaker Time/Current Curves (Phase Current)**  
**Series G N-Frame Circuit Breakers**  
**Eaton/Cutler-Hammer NG T W Electronic LD and SD with Flat Response**

**Catalog Types:** NGS, NGH, NGC, NGU, GNS, GNH, GNC, and GNU  
circuit breakers, three- and four-pole  
Trip Unit Types: T33 (LS), T35 (LSG)

**Interrupting Rating**

Breaker Type	IEC 60947-2 rms Sym. kA, 50/60 Hz					
	220/240V (Ue)		380/415V (Ue)		660/690V (Ue)	
	Icu	Ics	Icu	Ics	Icu	Ics
NGS	85	85	50	50	20	10
NGH	100	100	70	50	25	13
NGC	200	100	100	50	35	18

Breaker Type	UL/CSA rms Sym. kA, 50/60 Hz		
	240V	480V	600V
NGS	65	50	25
NGH	100	65	35
NGC	200	100	65
NGU <sup>5</sup>	200	150	65

**Notes:**

1. Curves accuracy applies between -20 to +40°C breaker ambient. For possible continuous ampere derating refer to Cutler-Hammer.
2. For high fault levels a fixed instantaneous override is provided at 14400 amperes, +/- 15%.
3. Total clearing times shown include the response times of the trip unit, the breaker opening, and the extinction of the arcing current.
4. Not UL/CSA listed.
5. 800A Maximum.

**1250 & 1200 Ampere Trip Unit Rating Plug**

Ampere Rating (I <sub>n</sub> )	Type	Pick-up Range Amperes
1250	Fixed	2500-10000 ④
1200	Fixed	2400-9600
1000	Fixed	2000-8000
900	Fixed	1800-7200
800	Fixed	1600-6400
700	Fixed	1400-5600
630	Fixed	1260-5040 ④
600	Fixed	1200-4800
600,800,1000,1200	Adjustable	1200-9600
600,800,1000,1200	Adjustable	1200-10000 ④

**800 Ampere Trip Unit Rating Plug**

Ampere Rating (I <sub>n</sub> )	Type	Pick-up Range Amperes
800	Fixed	1600-6400
700	Fixed	1400-5600
630	Fixed	1260-5040 ④
600	Fixed	1200-4800
550	Fixed	1100-4400
500	Fixed	1000-4000
450	Fixed	900-3600
400	Fixed	800-3200
400,500,600,800	Adjustable	800-6400
400,500,600,800	Adjustable	800-6400 ④

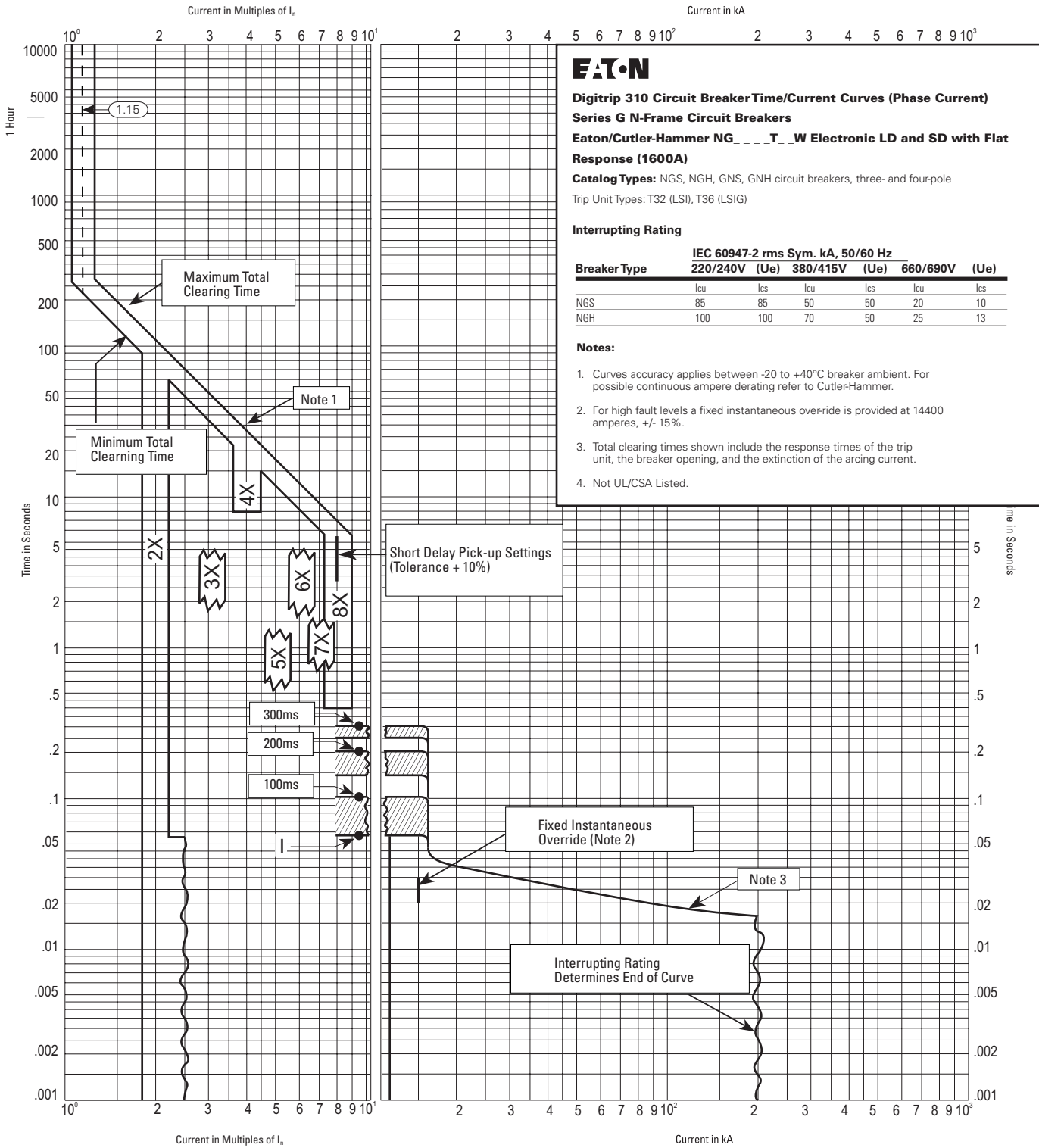

**EATON**  
**Digitrip 310 Circuit Breaker Time/Current Curves (Phase Current)**  
**Series G N-Frame Circuit Breakers**  
**Eaton/Cutler-Hammer NG \_ \_ \_ T \_ W Electronic LD and SD with Flat Response (1600A)**  
**Catalog Types:** NGS, NGH, GNS, GNH circuit breakers, three- and four-pole  
**Trip Unit Types:** T32 (LSI), T36 (LSIG)

**Interrupting Rating**

Breaker Type	IEC 60947-2 rms Sym. kA, 50/60 Hz					
	220/240V (Ue)	(Ue)	380/415V (Ue)	(Ue)	660/690V (Ue)	(Ue)
	Icu	Ics	Icu	Ics	Icu	Ics
NGS	85	85	50	50	20	10
NGH	100	100	70	50	25	13

**Notes:**

- Curves accuracy applies between -20 to +40°C breaker ambient. For possible continuous ampere derating refer to Cutler-Hammer.
- For high fault levels a fixed instantaneous override is provided at 14400 amperes, +/- 15%.
- Total clearing times shown include the response times of the trip unit, the breaker opening, and the extinction of the arcing current.
- Not UL/CSA Listed.

**1600 Ampere Trip Unit Rating Plug**  
**1600 A Frame**

Ampere Rating (In)	Type	Pick-up Range Amperes
800,1000,1250,1600	Adjustable	1600-12800 Ⓢ

## Catalog Number Selection

This information is presented only as an aid to understanding catalog numbers. It is not to be used to build catalog numbers for circuit breakers or trip units.

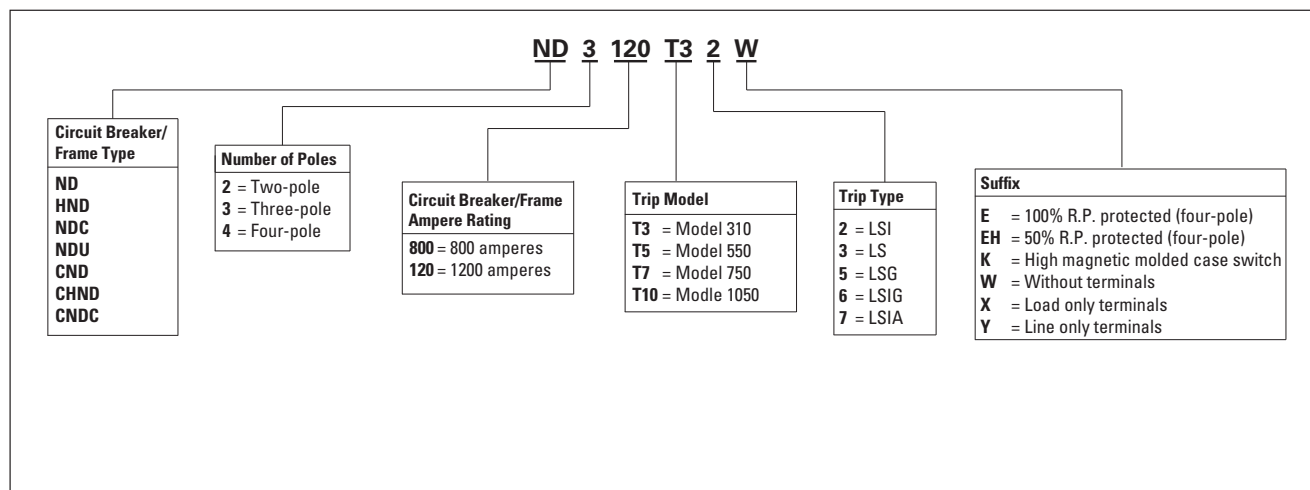

**Types ND, CND, HND, CHND, NDC, CNDC, NDU, NGU Equipped With Type NES Digitrip RMS 310 Trip Units With I<sup>2</sup>t Ramp Short Time Delay (Phase Protection)**



**Circuit Breaker Time/Current Curves (Phase Current)**

**Series C N-Frame Circuit Breakers**

**Equipped With Type NES Digitrip RMS 310 Trip Units**

The NES Digitrip RMS 310 Trip Units are AC only devices that employ microprocessor based technology that provides true RMS current sensing means for proper correlation with thermal characteristics of conductors and equipment. They are used with Circuit Breaker Types: ND, CND, HND, CHND, NDC, and CNDC.

**I<sup>2</sup>t Ramp Short Time Delay**

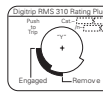

**Typical Trip Unit Nameplate**



**Available Rating Plugs**

Frame Rating Amperes (Max.)	Ampere Rating (I <sub>n</sub> )	Type	Catalog Number	Short Delay Pickup Range Amperes
800	800	Fixed	8NES800T	1600-6400
800	700	Fixed	8NES700T	1400-5600
800	630	Fixed	8NES630T (4)	1260-5040
800	600	Fixed	8NES600T	1200-4800
800	550	Fixed	8NES550T	1100-4400
800	500	Fixed	8NES500T	1000-4000
800	450	Fixed	8NES450T	900-3600
800	400	Fixed	8NES400T	800-3200
1200	400, 500, 600, 800	Adj.	A8NES800T1	800-6400
1200	400, 500, 600, 800	Adj.	A8NES800T2 (4)	800-6400
1200	1200	Fixed	12NES1200T	2400-9600
1200	1000	Fixed	12NES1000T	2000-8000
1200	900	Fixed	12NES900T (4)	1800-7200
1200	800	Fixed	12NES800T	1600-6400
1200	700	Fixed	12NES700T	1400-5600
1200	630	Fixed	12NES630T (4)	1260-5040
1200	600	Fixed	12NES600T	1200-4800
1200	600, 800, 1000, 1200	Adj.	A12NES1200T1	1200-9600

**Interrupting Rating**

Breaker Type	UL/CSA rms Sym. kA, 50/60 Hz		
	240V	480V	600V
ND, CND	65	50	25
HND, CHND	100	65	35
NDC, CNDC	200	100	50

Breaker Type	IEC 60947-2 rms Sym. kA, 50/60 Hz	
	240/240V	380/415V
ND, CND	65	50
HND, CHND	100	65
NDC, CNDC	200	100

**Notes:**

Curve accuracy applies from -20°C to +55°C ambient. For possible ampere derating for ambient above 40°C, refer to Eaton.

Digitrip RMS 310 trip units are suitable for functional field testing with test kit Cat. No. STK2. For field testing using primary injection methods, follow NEMA publication AB-4.

- ① There is a memory effect that can act to shorten the long delay. The memory effect comes into play if a current above the long delay pickup value exists for a time and then is cleared by the tripping of a downstream device or the circuit breaker itself. A subsequent overload will cause the circuit breaker to trip in shorter time than normal. The amount of time delay reduction is inverse to the amount of time that has elapsed since the previous overload. Approximately five minutes is required between overloads to completely reset the memory.
- ② For high fault current levels a fixed instantaneous override is provided at 14000A (Tolerance ±15%).
- ③ The end of the curve is determined by the interrupting rating of the circuit breaker. See above tabulation.
- ④ Not UL/CSA Listed.
- ⑤ Long Delay Pickup is 115% of I<sub>n</sub>, +/- 5%.

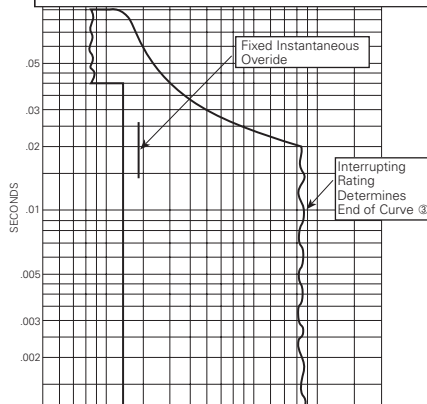
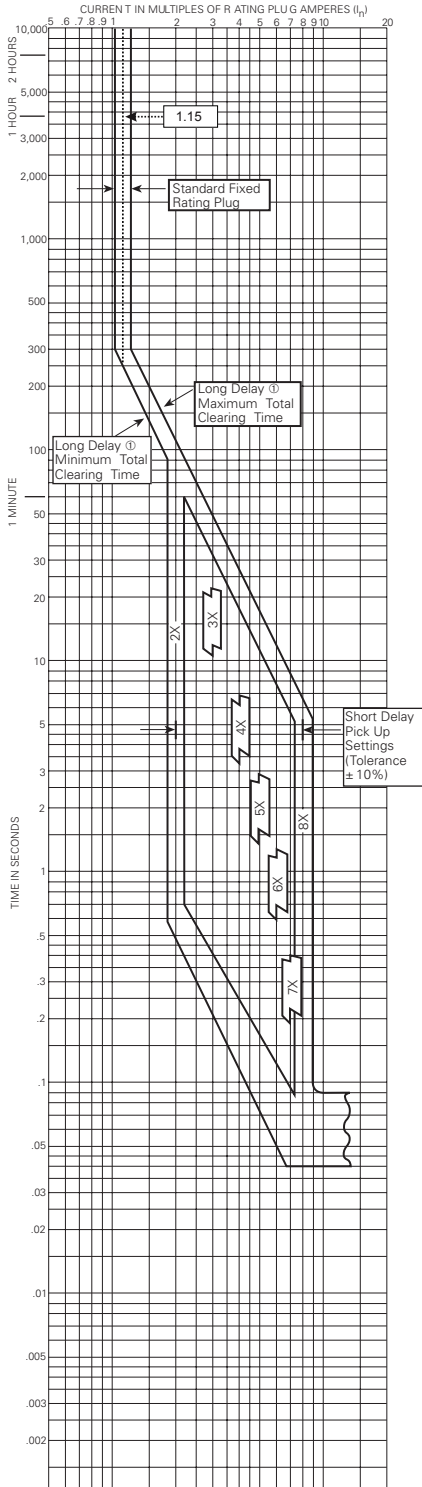

**Types ND, CND, HND, CHND, NDC, CNDC, NDU, NGU Equipped With Type NES Digitrip RMS 310 Trip Units With Adjustable Short Time Delay (Phase Protection)**



**Circuit Breaker Time/Current Curves (Phase Current)**

**Series C N-Frame Circuit Breakers**

**Equipped With Type NES Digitrip RMS 310 Trip Units**

The NES Digitrip RMS 310 Trip Units are AC only devices that employ microprocessor based technology that provides true RMS current sensing means for proper correlation with thermal characteristics of conductors and equipment. They are used with Circuit Breaker Types: ND, CND, HND, CHND, NDC, and CNDC.

**Adjustable Short Time Delay Typical Trip Unit Nameplate**

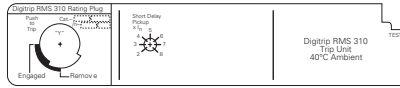

**Available Rating Plugs**

Frame Rating Amperes (Max.)	Ampere Rating ( $I_n$ )	Type	Catalog Number	Short Delay Pickup Range Amperes
800	800	Fixed	8NES800T	1600-6400
800	700	Fixed	8NES700T	1400-5600
800	630	Fixed	8NES630T (4)	1260-5040
800	600	Fixed	8NES600T	1200-4800
800	550	Fixed	8NES550T	1100-4400
800	500	Fixed	8NES500T	1000-4000
800	450	Fixed	8NES450T	900-3600
800	400	Fixed	8NES400T	800-3200
1200	400, 500, 600, 800	Adj.	A8NES800T1	800-6400
1200	400, 500, 600, 800	Adj.	A8NES800T2 (4)	800-6400
1200	1200	Fixed	12NES1200T	2400-9600
1200	1000	Fixed	12NES1000T	2000-8000
1200	900	Fixed	12NES900T (4)	1800-7200
1200	800	Fixed	12NES800T	1600-6400
1200	700	Fixed	12NES700T	1400-5600
1200	630	Fixed	12NES630T (4)	1260-5040
1200	600	Fixed	12NES600T	1200-4800
1200	600, 800, 1000, 1200	Adj.	A12NES1200T1	1200-9600

**Interrupting Rating**

Breaker Type	UL/CSA rms Sym. kA, 50/60 Hz		
	240V	480V	600V
ND, CND	65	50	25
HND, CHND	100	65	35
NDC, CNDC	200	100	50

Breaker Type	IEC 60947-2 rms Sym. kA, 50/60 Hz	
	240/240V	380/415V
ND, CND	65	50
HND, CHND	100	65
NDC, CNDC	200	100

**Notes:**

ICS = .25 ICU, ICW = 15 kA @ .5S,  $U_{imp}$  = 8kV

Curve accuracy applies from -20°C to +55°C ambient. For possible ampere derating for ambient above 40°C, refer to Eaton.

Digitrip RMS 310 trip units are suitable for functional field testing with test kit Cat. No. STK2. For field testing using primary injection methods, follow NEMA publication AB-4.

- There is a memory effect that can act to shorten the long delay. The memory effect comes into play if a current above the long delay pick up value exists for a time and then is cleared by the tripping of a downstream device or the circuit breaker itself. A subsequent overload will cause the circuit breaker to trip in shorter time than normal. The amount of time delay reduction is inverse to the amount of time that has elapsed since the previous overload. Approximately five minutes is required between overloads to completely reset the memory.
- For high fault current levels a fixed instantaneous override is provided at 14000A (Tolerance  $\pm 15\%$ ).
- The end of the curve is determined by the interrupting rating of the circuit breaker. See above tabulation.
- Not UL/CSA Listed.
- Long Delay Pickup is 115% of  $I_n$ ,  $\pm 5\%$ .

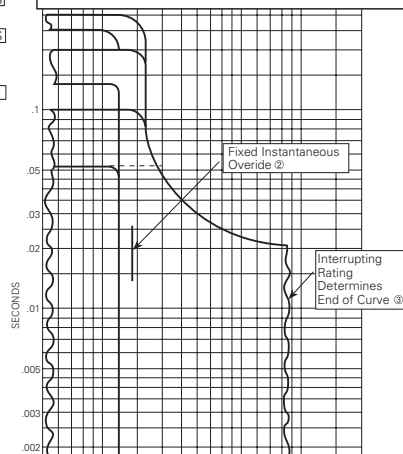
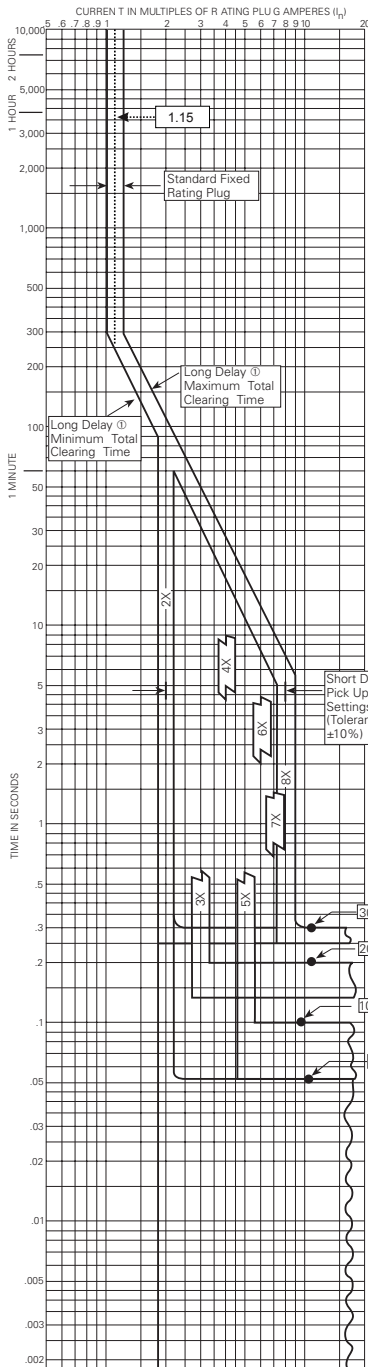

**Types ND, CND, HND, CHND, NDC, CNDC, NDU, Equipped With Type NES Digitrip RMS 310 Trip Units With Ground Fault Protection**

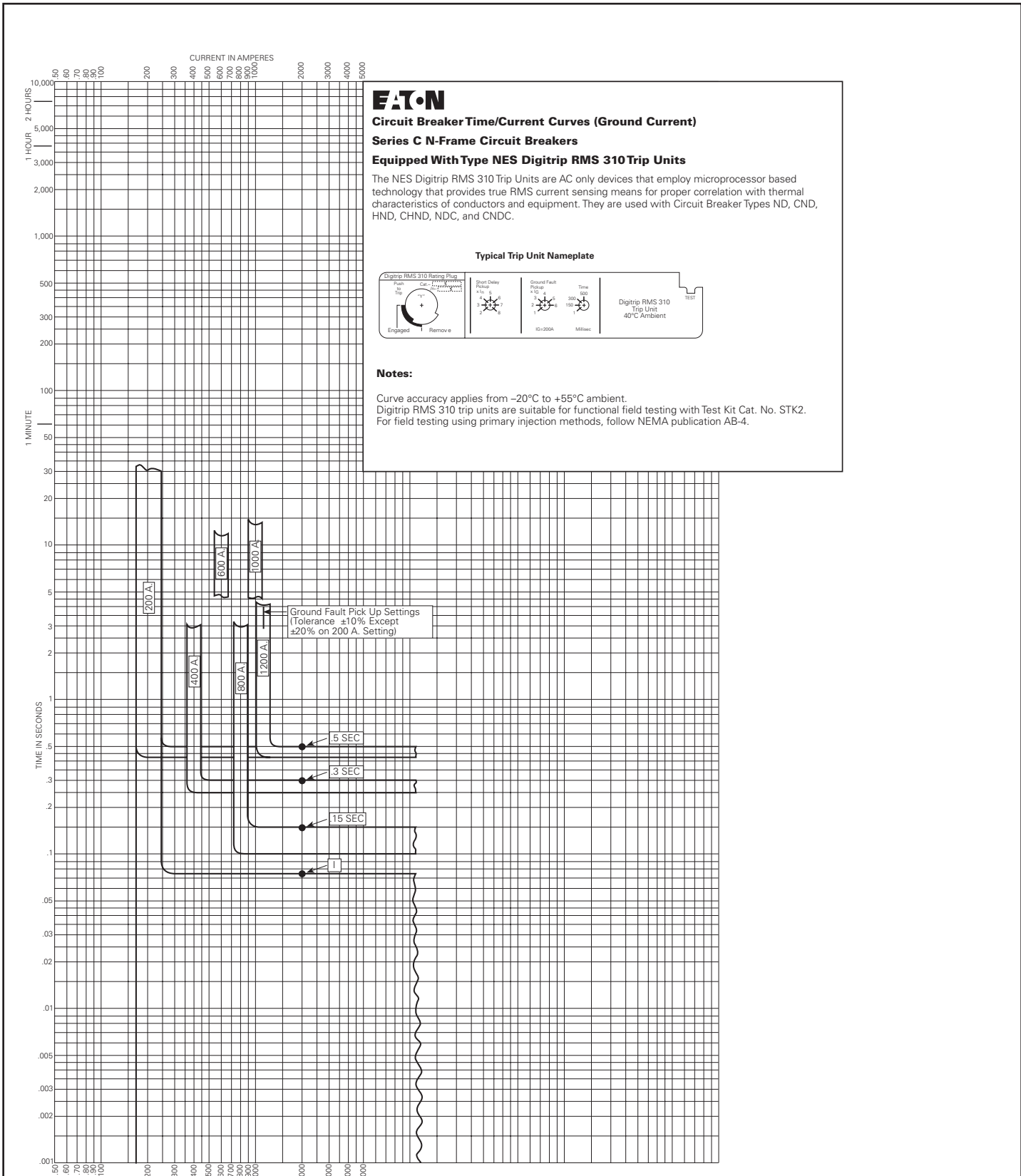

**N-Frame Circuit Breakers Equipped with Digitrip OPTIM Trip Units; Long Delay I<sup>2</sup>t, Short Delay I<sup>2</sup>t**

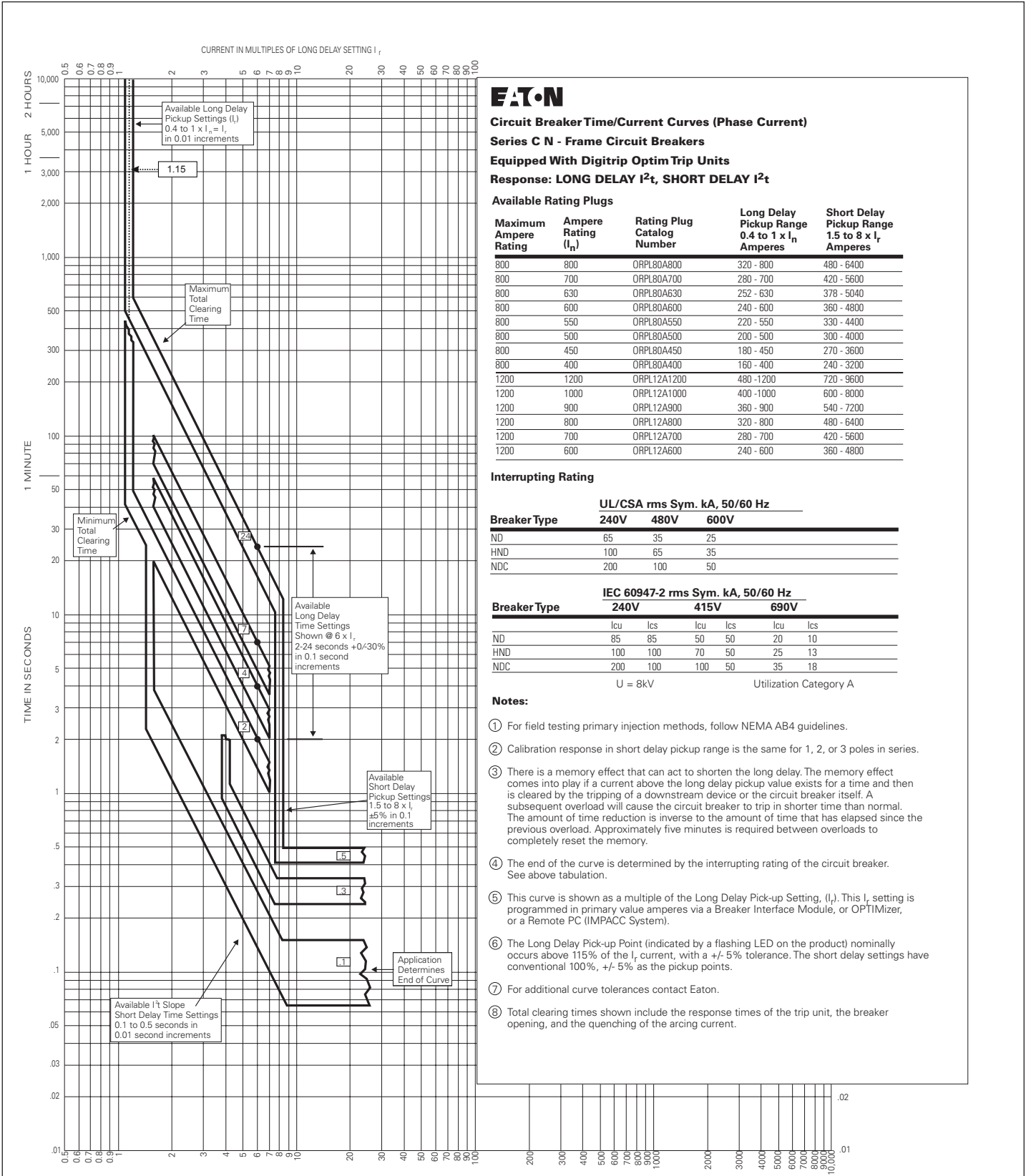

**Circuit Breaker Time/Current Curves (Phase Current)**

**Series C N - Frame Circuit Breakers**

**Equipped With Digitrip Optim Trip Units**

**Response: LONG DELAY I<sup>2</sup>t, SHORT DELAY I<sup>2</sup>t**

**Available Rating Plugs**

Maximum Ampere Rating	Ampere Rating (I <sub>n</sub> )	Rating Plug Catalog Number	Long Delay Pickup Range 0.4 to 1 x I <sub>n</sub> Amperes	Short Delay Pickup Range 1.5 to 8 x I <sub>r</sub> Amperes
800	800	ORPL80A800	320 - 800	480 - 6400
800	700	ORPL80A700	280 - 700	420 - 5600
800	630	ORPL80A630	252 - 630	378 - 5040
800	600	ORPL80A600	240 - 600	360 - 4800
800	550	ORPL80A550	220 - 550	330 - 4400
800	500	ORPL80A500	200 - 500	300 - 4000
800	450	ORPL80A450	180 - 450	270 - 3600
800	400	ORPL80A400	160 - 400	240 - 3200
1200	1200	ORPL12A1200	480 - 1200	720 - 9600
1200	1000	ORPL12A1000	400 - 1000	600 - 8000
1200	900	ORPL12A900	360 - 900	540 - 7200
1200	800	ORPL12A800	320 - 800	480 - 6400
1200	700	ORPL12A700	280 - 700	420 - 5600
1200	600	ORPL12A600	240 - 600	360 - 4800

**Interrupting Rating**

Breaker Type	UL/CSA rms Sym. kA, 50/60 Hz		
	240V	480V	600V
ND	65	35	25
HND	100	65	35
NDC	200	100	50

Breaker Type	IEC 60947-2 rms Sym. kA, 50/60 Hz					
	240V		415V		690V	
	I <sub>cu</sub>	I <sub>cs</sub>	I <sub>cu</sub>	I <sub>cs</sub>	I <sub>cu</sub>	I <sub>cs</sub>
ND	85	85	50	50	20	10
HND	100	100	70	50	25	13
NDC	200	100	100	50	35	18

U = 8kV Utilization Category A

**Notes:**

- For field testing primary injection methods, follow NEMA AB4 guidelines.
- Calibration response in short delay pickup range is the same for 1, 2, or 3 poles in series.
- There is a memory effect that can act to shorten the long delay. The memory effect comes into play if a current above the long delay pickup value exists for a time and then is cleared by the tripping of a downstream device or the circuit breaker itself. A subsequent overload will cause the circuit breaker to trip in shorter time than normal. The amount of time reduction is inverse to the amount of time that has elapsed since the previous overload. Approximately five minutes is required between overloads to completely reset the memory.
- The end of the curve is determined by the interrupting rating of the circuit breaker. See above tabulation.
- This curve is shown as a multiple of the Long Delay Pick-up Setting, (I<sub>r</sub>). This I<sub>r</sub> setting is programmed in primary value amperes via a Breaker Interface Module, or OPTIMizer, or a Remote PC (IMPACC System).
- The Long Delay Pick-up Point (indicated by a flashing LED on the product) nominally occurs above 115% of the I<sub>r</sub> current, with a +/- 5% tolerance. The short delay settings have conventional 100%, +/- 5% as the pickup points.
- For additional curve tolerances contact Eaton.
- Total clearing times shown include the response times of the trip unit, the breaker opening, and the quenching of the arcing current.

N-Frame Circuit Breakers Equipped with Digitrip OPTIM Trip Units; Long Delay I<sup>2</sup>t, Short Delay Flat

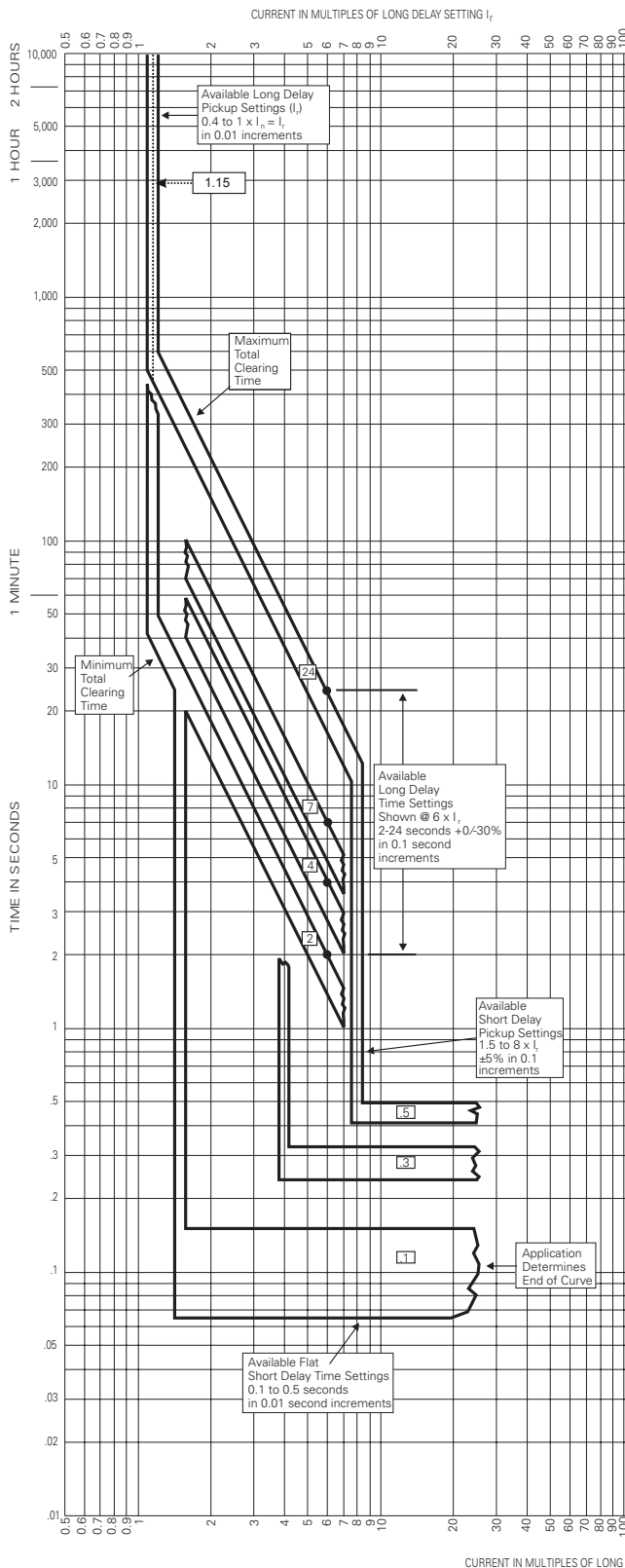

**Circuit Breaker Time/Current Curves (Phase Current)**

**Series C N - Frame Circuit Breakers**

**Equipped With Digitrip Optim Trip Units**

**Response: LONG DELAY I<sup>2</sup>t, SHORT DELAY FLAT**

**Available Rating Plugs**

Maximum Ampere Rating	Ampere Rating ( $I_n$ )	Rating Plug Catalog Number	Long Delay Pickup Range 0.4 to $1 \times I_n$ Amperes	Short Delay Pickup Range 1.5 to $8 \times I_n$ Amperes
800	800	ORPL80A800	320 - 800	480 - 6400
800	700	ORPL80A700	280 - 700	420 - 5600
800	630	ORPL80A630	252 - 630	378 - 5040
800	600	ORPL80A600	240 - 600	360 - 4800
800	550	ORPL80A550	220 - 550	330 - 4400
800	500	ORPL80A500	200 - 500	300 - 4000
800	450	ORPL80A450	180 - 450	270 - 3600
800	400	ORPL80A400	160 - 400	240 - 3200
1200	1200	ORPL12A1200	480 - 1200	720 - 9600
1200	1000	ORPL12A1000	400 - 1000	600 - 8000
1200	900	ORPL12A900	360 - 900	540 - 7200
1200	800	ORPL12A800	320 - 800	480 - 6400
1200	700	ORPL12A700	280 - 700	420 - 5600
1200	600	ORPL12A600	240 - 600	360 - 4800

**Interrupting Rating**

Breaker Type	UL/CSA rms Sym. kA, 50/60 Hz		
	240V	480V	600V
ND	65	35	25
HND	100	65	35
NDC	200	100	50

Breaker Type	IEC 60947-2 rms Sym. kA, 50/60 Hz					
	240V		415V		690V	
	Icu	Ics	Icu	Ics	Icu	Ics
ND	85	85	50	50	20	10
HND	100	100	70	50	25	13
NDC	200	100	100	50	35	18

U = 8kV

Utilization Category A

**Notes:**

- For field testing primary injection methods, follow NEMA AB4 guidelines.
- Calibration response in short delay pickup range is the same for 1, 2, or 3 poles in series.
- There is a memory effect that can act to shorten the long delay. The memory effect comes into play if a current above the long delay pickup value exists for a time and then is cleared by the tripping of a downstream device or the circuit breaker itself. A subsequent overload will cause the circuit breaker to trip in shorter time than normal. The amount of time reduction is inverse to the amount of time that has elapsed since the previous overload. Approximately five minutes is required between overloads to completely reset the memory.
- The end of the curve is determined by the interrupting rating of the circuit breaker. See above tabulation.
- This curve is shown as a multiple of the Long Delay Pick-up Setting, ( $I_L$ ). This  $I_L$  setting is programmed in primary value amperes via a Breaker Interface Module, or OPTIMizer, or a Remote PC (IMPACC System).
- The Long Delay Pick-up Point (indicated by a flashing LED on the product) nominally occurs above 115% of the  $I_L$  current, with a  $\pm 5\%$  tolerance. The short delay settings have conventional 100%,  $\pm 5\%$  as the pickup points.
- For additional curve tolerances contact Eaton.
- Total clearing times shown include the response times of the trip unit, the breaker opening, and the quenching of the arcing current.

**N-Frame Circuit Breakers Equipped with Digitrip OPTIM Trip Units; Long Delay I<sup>4</sup>t, Short Delay Flat**

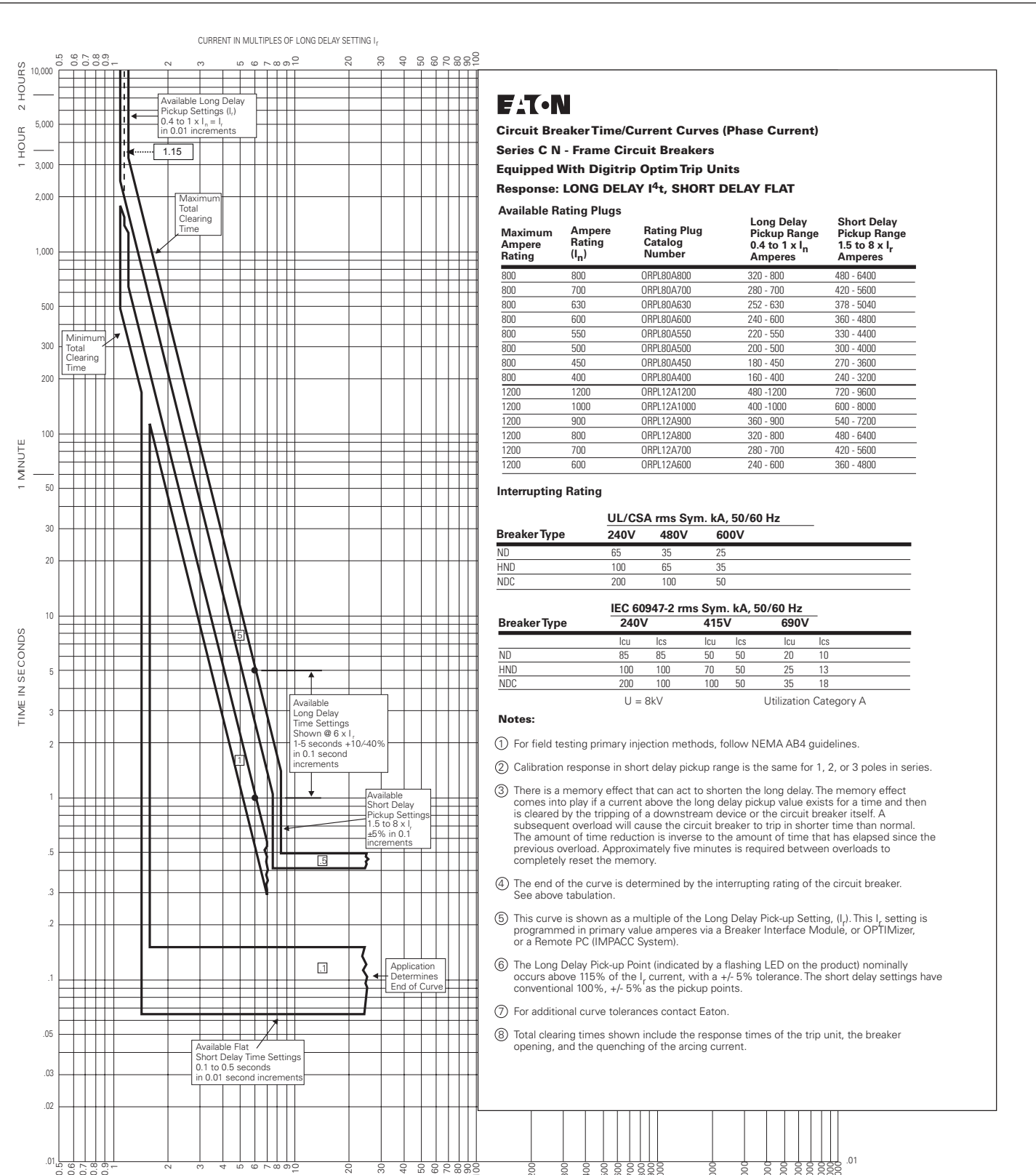

**Circuit Breaker Time/Current Curves (Phase Current)**

**Series C N - Frame Circuit Breakers**

Equipped With Digitrip Optim Trip Units

Response: **LONG DELAY I<sup>4</sup>t, SHORT DELAY FLAT**

**Available Rating Plugs**

Maximum Ampere Rating	Ampere Rating ( $I_n$ )	Rating Plug Catalog Number	Long Delay Pickup Range 0.4 to $1 \times I_n$ Amperes	Short Delay Pickup Range 1.5 to $8 \times I_r$ Amperes
800	800	ORPL80A800	320 - 800	480 - 6400
800	700	ORPL80A700	280 - 700	420 - 5600
800	630	ORPL80A630	252 - 630	378 - 5040
800	600	ORPL80A600	240 - 600	360 - 4800
800	550	ORPL80A550	220 - 550	330 - 4400
800	500	ORPL80A500	200 - 500	300 - 4000
800	450	ORPL80A450	180 - 450	270 - 3600
800	400	ORPL80A400	160 - 400	240 - 3200
1200	1200	ORPL12A1200	480 - 1200	720 - 9600
1200	1000	ORPL12A1000	400 - 1000	600 - 8000
1200	900	ORPL12A900	360 - 900	540 - 7200
1200	800	ORPL12A800	320 - 800	480 - 6400
1200	700	ORPL12A700	280 - 700	420 - 5600
1200	600	ORPL12A600	240 - 600	360 - 4800

**Interrupting Rating**

Breaker Type	UL/CSA rms Sym. kA, 50/60 Hz		
	240V	480V	600V
ND	65	35	25
HND	100	65	35
NDC	200	100	50

Breaker Type	IEC 60947-2 rms Sym. kA, 50/60 Hz					
	240V		415V		690V	
	I <sub>cu</sub>	I <sub>cs</sub>	I <sub>cu</sub>	I <sub>cs</sub>	I <sub>cu</sub>	I <sub>cs</sub>
ND	85	85	50	50	20	10
HND	100	100	70	50	25	13
NDC	200	100	100	50	35	18

U = 8kV Utilization Category A

**Notes:**

- For field testing primary injection methods, follow NEMA AB4 guidelines.
- Calibration response in short delay pickup range is the same for 1, 2, or 3 poles in series.
- There is a memory effect that can act to shorten the long delay. The memory effect comes into play if a current above the long delay pickup value exists for a time and then is cleared by the tripping of a downstream device or the circuit breaker itself. A subsequent overload will cause the circuit breaker to trip in shorter time than normal. The amount of time reduction is inverse to the amount of time that has elapsed since the previous overload. Approximately five minutes is required between overloads to completely reset the memory.
- The end of the curve is determined by the interrupting rating of the circuit breaker. See above tabulation.
- This curve is shown as a multiple of the Long Delay Pick-up Setting, ( $I_L$ ). This  $I_L$  setting is programmed in primary value amperes via a Breaker Interface Module, or OPTIMizer, or a Remote PC (IMPACC System).
- The Long Delay Pick-up Point (indicated by a flashing LED on the product) nominally occurs above 115% of the  $I_L$  current, with a  $\pm 5\%$  tolerance. The short delay settings have conventional 100%,  $\pm 5\%$  as the pickup points.
- For additional curve tolerances contact Eaton.
- Total clearing times shown include the response times of the trip unit, the breaker opening, and the quenching of the arcing current.

**N-Frame Circuit Breakers Equipped with Digitrip OPTIM Trip Units; Instantaneous and Override**

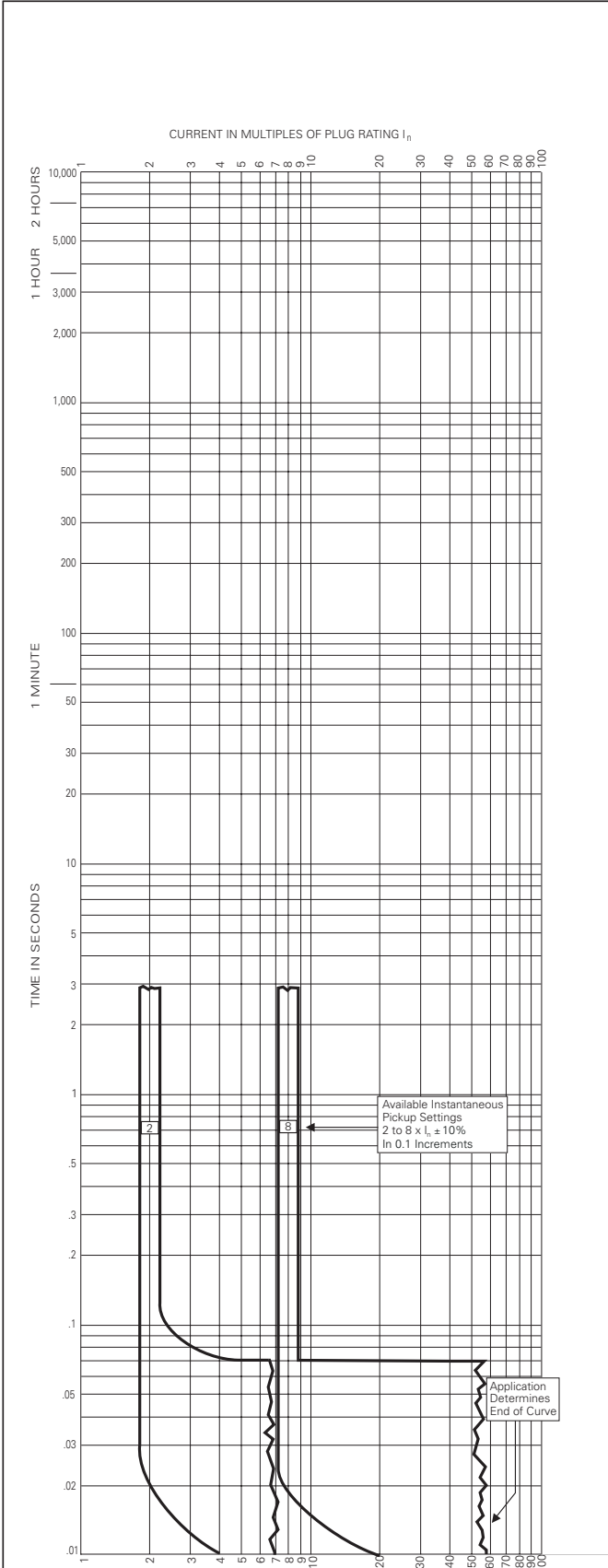

**Circuit Breaker Time/Current Curves (Phase Current)**

**Series C N - Frame Circuit Breakers**

**Equipped With Digitrip Optim Trip Units**

**Response: INSTANTANEOUS AND OVERRIDE**

**Available Rating Plugs**

Maximum Ampere Rating	Ampere Rating ( $I_n$ )	Rating Plug Catalog Number	Long Delay Pickup Range 0.4 to 1 x $I_n$ Amperes	Short Delay Pickup Range 1.5 to 8 x $I_r$ Amperes
800	800	ORPL80A800	320 - 800	480 - 6400
800	700	ORPL80A700	280 - 700	420 - 5600
800	630	ORPL80A630	252 - 630	378 - 5040
800	600	ORPL80A600	240 - 600	360 - 4800
800	550	ORPL80A550	220 - 550	330 - 4400
800	500	ORPL80A500	200 - 500	300 - 4000
800	450	ORPL80A450	180 - 450	270 - 3600
800	400	ORPL80A400	160 - 400	240 - 3200
1200	1200	ORPL12A1200	480 - 1200	720 - 9600
1200	1000	ORPL12A1000	400 - 1000	600 - 8000
1200	900	ORPL12A900	360 - 900	540 - 7200
1200	800	ORPL12A800	320 - 800	480 - 6400
1200	700	ORPL12A700	280 - 700	420 - 5600
1200	600	ORPL12A600	240 - 600	360 - 4800

**Interrupting Rating**

**UL/CSA rms Sym. kA, 50/60 Hz**

Breaker Type	240V	480V	600V
ND	65	35	25
HND	100	65	35
NDC	200	100	50

**IEC 60947-2 rms Sym. kA, 50/60 Hz**

Breaker Type	240V		415V		690V	
	I <sub>cu</sub>	I <sub>cs</sub>	I <sub>cu</sub>	I <sub>cs</sub>	I <sub>cu</sub>	I <sub>cs</sub>
ND	85	85	50	50	20	10
HND	100	100	70	50	25	13
NDC	200	100	100	50	35	18

U = 8kV

Utilization Category A

**Notes:**

- For field testing primary injection methods, follow NEMA AB4 guidelines.
- Calibration response in short delay pickup range is the same for 1, 2, or 3 poles in series.
- There is a memory effect that can act to shorten the long delay. The memory effect comes into play if a current above the long delay pickup value exists for a time and then is cleared by the tripping of a downstream device or the circuit breaker itself. A subsequent overload will cause the circuit breaker to trip in shorter time than normal. The amount of time reduction is inverse to the amount of time that has elapsed since the previous overload. Approximately five minutes is required between overloads to completely reset the memory.
- The end of the curve is determined by the interrupting rating of the circuit breaker. See above tabulation.
- The instantaneous settings have conventional 100%, +/- 10% as the pickup points.
- For additional curve tolerances contact Eaton.
- Total clearing times shown include the response times of the trip unit, the breaker opening, and the quenching of the arcing current.

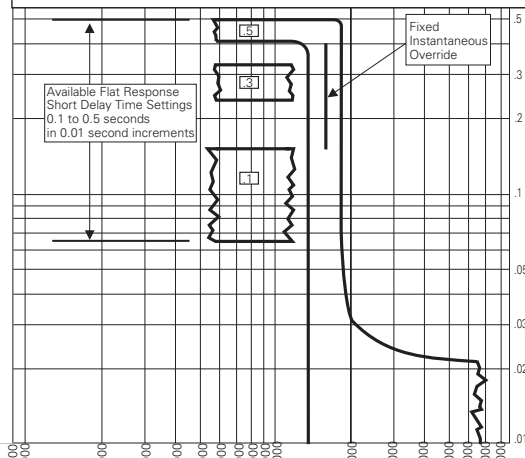

**N-Frame Circuit Breakers Equipped with Digitrip OPTIM Trip Units; Ground Fault or Ground Fault Alarm Only**



**Circuit Breaker Time/Current Curves (Ground Current)**

**Series C N - Frame Circuit Breakers**

**Equipped With Digitrip Optim Trip Units**

**Response: GROUND FAULT TRIP OR GROUND FAULT ALARM ONLY**

**Available Rating Plugs**

Maximum Ampere Rating	Ground Fault Pickup Range 0.2 to 1.0 x I <sub>n</sub> Amperes
800	160-800
1200	240-1200

**Interrupting Rating**

Breaker Type	UL/CSA rms Sym. kA, 50/60 Hz		
	240V	480V	600V
ND	65	35	25
HND	100	65	35
NDC	200	100	50

Breaker Type	IEC 60947-2 rms Sym. kA, 50/60 Hz					
	240V		415V		690V	
	I <sub>cu</sub>	I <sub>cs</sub>	I <sub>cu</sub>	I <sub>cs</sub>	I <sub>cu</sub>	I <sub>cs</sub>
ND	85	85	50	50	20	10
HND	100	100	70	50	25	13
NDC	200	100	100	50	35	18

**Notes:**

- For field testing primary injection methods, follow NEMA AB4 guidelines.
- Calibration response in short delay pickup range is the same for 1, 2, or 3 poles in series.
- There is a memory effect that can act to shorten the long delay. The memory effect comes into play if a current above the long delay pickup value exists for a time and then is cleared by the tripping of a downstream device or the circuit breaker itself. A subsequent overload will cause the circuit breaker to trip in shorter time than normal. The amount of time reduction is inverse to the amount of time that has elapsed since the previous overload. Approximately five minutes is required between overloads to completely reset the memory.
- The end of the curve is determined by the interrupting rating of the circuit breaker. See above tabulation.
- The ground fault settings have conventional 100%, +/- 10% as the pickup points.
- For additional curve tolerances contact Eaton.
- Total clearing times shown include the response times of the trip unit, the breaker opening, and the quenching of the arcing current.

