

# Compax3

**C3S - Low to Medium Power**  
**C3H - High Power**  
**C3M - Multi-Axis**

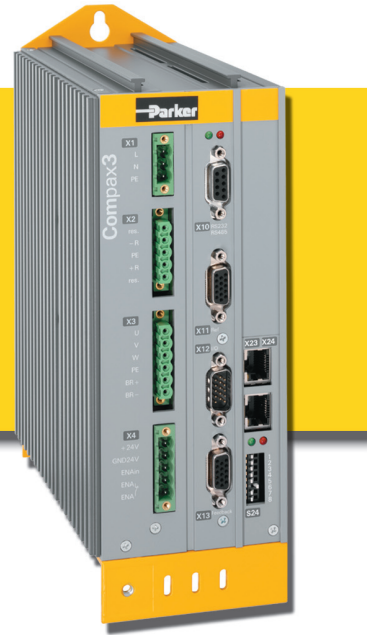

## Compact, Intelligent and Powerful Industrial Servo Drives & Drive/Controllers

With its high-performance and modular design, the Compax3 family of industrial servo drives and drive/controllers offers a new level of servo performance and flexibility. The modular structure of the Compax3 family allows options such as intelligent motion controllers, fieldbus interfaces and industry standard motor feedback. In addition, numerous expansion options can be added to the standard product in order to optimize the capabilities required for today's demanding servo applications. The family is offered in two variations: standalone (C3S and C3H) and a DC busfed multi-axis version (C3M). Both have all the same options and performance.

### Compax3 Features

- Available in both 120/240 VAC and 480 VAC input versions
- Integrated safety: EN954-1 Category 3 technology

- Current output from 2.5 A (rms) continuous to 155 A (rms) continuous
- Resolver, encoder, high-resolution SinCos® or Stegmann Absolute rotary encoder feedback (single- or multi-turn) or Heidenhain Endat 2.1
- Internal regeneration circuitry; external resistor connections for additional power dissipation
- Easy-to-use wizards-based configuration and programming via C3 ServoManager™ software package
- Full diagnostic, tuning and 4-channel oscilloscope tools provided in the standard C3 ServoManager™ software
- Software input simulation
- Auto-load identification (auto-tuning)
- CE (EMC & LVD), UL and cUL recognized



### T10 Features

- Base servo drive
- ±10 V analog
- Step and direction
- Torque/velocity control
- Position control
- Encoder tracking

### T11 Features

- Servo positioning drive
- Up to 31 stored profiles
- Profile select via digital inputs
- Multi-profile sequences
- Multiple homing routines
- Profibus
- CANopen
- DeviceNet
- ETHERNET Powerlink

### T30 Features

- Full-featured programmable drive/controller
- IEC61131-3 programming flexibility
- PLCopen, Parker motion function blocks
- Complex motion
- Profibus
- CANopen
- DeviceNet
- ETHERNET Powerlink

### T40 Features

- T30 programming capability
- Electronic cam control
- Superimpose motion
- Electronic gearing
- Position capture
- Profibus
- CANopen
- DeviceNet
- HEDA
- ETHERNET Powerlink

# Compax3 T10

## Basic Drive

The Compax3 T10 technology level is a compact industrial digital servo drive available in 16 power levels producing up to 155 A (rms) continuous current and covering a broad range of input voltages. The T10 is the base Compax3 drive model and is designed for use with an external motion controller in centralized motion control systems.

Compax3 T10 drives are well-suited for combining with Parker's ACR or 6K motion controller products and together create a formidable multi-axis servo system. Parker also offers pre-made analog command cables for quick and efficient connectivity between any T10 drive and ACR or 6K controller.

The Compax3 T10 accepts both  $\pm 10$  V analog command signals and step-and-direction command signals for operating as a torque, velocity or position control drive.

Compax3 products are easily configurable via RS232/485 using Parker's C3 ServoManager™ software running on a PC or by utilizing the optional BDM keypad interface module. Using the C3 ServoManager software could not be easier. All setup is accomplished via intuitive drive configuration wizards and basic application information. Commissioning is even faster with the addition of software input simulation and auto-tuning.

## Compax3 T10 Features

- 120 - 480 VAC power input range
- Continuous current output from 2.5 A (rms) to 155 A (rms)
- Resolver, encoder or high-resolution SinCos® Hiperface™ and Endat 2.1 feedback
- $\pm 10$  V analog command signals
- 5V/24V step-and-direction command signals
- Torque, velocity or position control modes
- Encoder tracking capability
- CE (EMC & LVD), UL and cUL

## Compax3 T10 Accessories

- Refer to the [Compax3 Accessories](#) section listed on page 15 of this catalog

Shown: Parker's ACR9000 multi-axis controller with Compax3 I10 T10 drives using  $\pm 10$ VDC command voltage

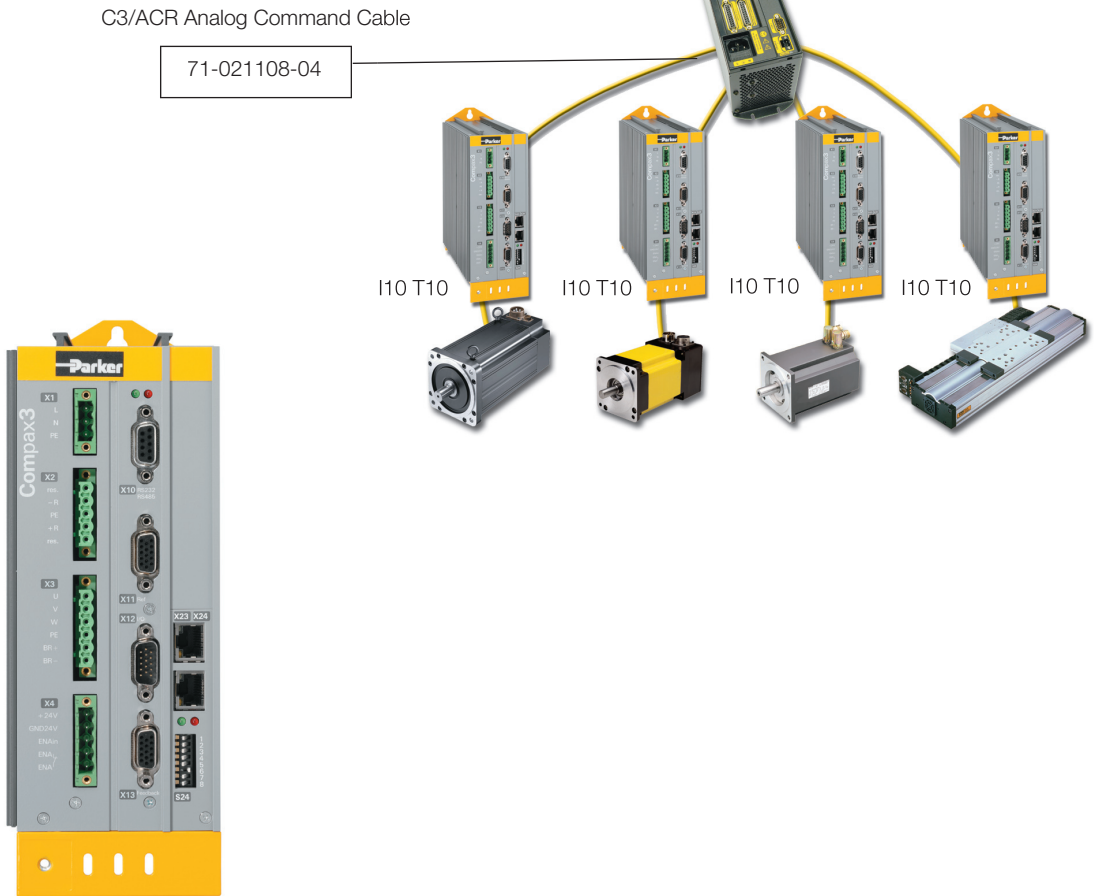

## Compax3 T11

### Servo Positioning Drive

The Compax3 T11 technology level integrates simple position control capabilities into the standard Compax3 drive. The I11 T11 is a basic positioning drive capable of retaining up to 31 motion profiles in memory. Individual motion profiles are assigned a binary input mask and are triggered when the appropriate input pattern is set or via internal control bit manipulation from the optional fieldbus interfaces. Acceleration, deceleration, target speed, and target position are all user-configurable for each profile by entering values into a software table.

For more diverse applications, the Compax3 I12 T11 offers all the capabilities of the I11 T11, but also includes functionality such as electronic gearing and registration-based moves – all selectable via onboard I/O or serial interface (RS232/RS485). The I12 T11 also is compatible with Parker's HEDA high-speed following bus option.

Compax3 products are easily configurable via RS232/485 using Parker's C3 ServoManager™ PC software. All setup is accomplished via intuitive drive configuration wizards and basic application information. Commissioning is even faster with the addition of software input simulation and auto-tuning. If desired, customers can also copy existing T11 configuration files to/from other T11 units – without the need for a PC – using the optional BDM01/01 keypad interface module.

Although the Compax3 T11 uses standard resolver feedback, it can also be equipped with quadrature encoder or high-resolution Stegmann or SinCos® Hiperface™ encoders with multi-turn absolute feedback capability. The latest addition has Endat 2.1 support

#### Available with ETHERNET Powerlink

- Use in conjunction with ACR9040 as motion bus
- Use for TCP/IP communication
- Use with other EPL master units.

#### Compax3 I11 T11 Features

- 120 - 480 VAC power input range
- Continuous current output from 2.5 A (rms) to 155 A (rms)
- Resolver, encoder, high-resolution SinCos® or Stegmann Absolute rotary encoder feedback (single- or multi-turn) or Heidenhain Endat 2.1
- SSI encoder as a source for gearing, cam shapes and external position measurement
- Up to 31 move profiles storable in non-volatile flash memory
- Absolute or relative positioning via 8 digital inputs, 4 digital outputs
- Homing and jogging functionality
- Software travel limits
- "Dynamic positioning" – allows the changing of target position while a move is in progress
- Adjustable jerk (S-curve) limitation
- Optional fieldbus interfaces (CANopen, Profibus DP, DeviceNet and ETHERNET Powerlink)
- CE (EMC & LVD), UL and cUL

#### Compax3 I12 T11 Features

All I11 T11 capabilities, plus:

- Electronic gearing (following)
- Registration input (800 ns position-capture speed)
- Continuous velocity, registration-based moves
- 16 digital inputs, 8 digital outputs
- Hardware end-of-travel limit support
- Programmable pattern outputs
- Optional HEDA following bus option
- Requires M12 option

#### Compax3 T11 Accessories

- Refer to the [Compax3 Accessories](#) section listed on page 15 of this catalog



## Compax3 T30

### IEC61131-3 Drive/Controller

The Compax3 T30 technology level is a compact industrial digital servo drive/controller available in six power levels producing up to 30 A (rms) continuous current and covering a broad range of input voltages. The T30 is a servo drive with fully programmable IEC61131-3 motion controller capability. The IEC61131-3 programming environment offers the ultimate in programming flexibility and power.

Compax3 T30 users may choose to develop their application code from any of six graphical, ladder or text-based IEC programming formats. Users have the freedom to develop their application in whichever programming style they are most comfortable; or, if desired, they may use any combination of these languages within the same application project. The motion capabilities of the Compax3 T30 are easily available to the user via PLCopen standard function blocks as well as more complex motion function blocks supplied by Parker Hannifin. Optional fieldbus interfaces allow simple and effective data exchange to higher-level systems.

The Compax3 is easily configurable via RS232/485 using Parker's C3 ServoManager™ software running on a PC or by downloading an existing configuration file from another T30 unit via the optional BDM01/01 keypad interface module. Using the C3 ServoManager software could not be easier. Commissioning is even faster with the addition of software input simulation and auto-tuning. All setup is accomplished via intuitive drive configuration wizards and basic application information. The CoDeSys IEC programming editor can also be launched directly from the C3 ServoManager software.

Although the Compax3 T30 uses standard resolver feedback, it can also be equipped with quadrature encoder, high-resolution Stegmann or SinCos® Hiperface™ encoder with single- or multi-turn absolute feedback capability or Heidenhain Endat 2.1.

### Compax3 T30 Features

- 120 - 480 VAC power input range
- Continuous current output from 2.5 A (rms) to 30 A (rms)
- Resolver, encoder, high-resolution SinCos® or Stegmann Absolute rotary encoder feedback (single- or multi-turn) or Heidenhain Endat 2.1
- SSI encoder as a source for gearing, cam shapes and external position measurement
- Fully programmable IEC61131-3 single-axis drive/controller
- PLCopen and Parker motion function blocks
- 6 programming formats to choose from – CFC, LD, FBD, SFC, ST and IL
- Program memory – more than 5000 instruction lines
- High-level motion capability and machine control capability in one package
- 8 digital inputs/4 digital outputs
- Registration input (800 ns position-capture speed)
- Optional expansion I/O – additional 12 digital I/O points configurable for inputs or outputs, remote I/O with CANopen
- Optional fieldbus interfaces (CANopen, Profibus DP, DeviceNet and ETHERNET Powerlink)
- CE (EMC & LVD), UL and cUL

### Compax3 T30 Accessories

- Refer to the [Compax3 Accessories](#) section listed on page 15 of this catalog



## Compax3 T40

### IEC61131-3 Drive/Controller with Electronic Camming

The Compax3 T40 technology level is a compact industrial digital servo drive available in six power levels producing up to 30 A (rms) continuous current and covering a broad range of input voltages. The T40 is a servo drive with fully programmable IEC61131-3 motion controller and advanced electronic camming and gearing capabilities.

The Compax3 T40 represents the ultimate in programming flexibility and power within the Compax3 drive family. In addition to all of the programming capabilities of the Compax3 T30, the T40 includes electronic gearing and cam control capabilities, position capture and programmable limit switch (PLS) functionality. Electronic cams are created graphically using the powerful, wizard-based Cam Designer tool built into the C3 ServoManager™ software package. All this can be combined with Parker's optional HEDA interface, a high-speed, real-time following bus specifically designed for line-shafting or multi-axis following applications. The motion capabilities of the Compax3 T40 are easily available to the user via PLCopen standard function blocks as well as more complex motion function blocks supplied by Parker Hannifin. Optional fieldbus interfaces allow simple and effective data exchange to higher-level systems.

The Compax3 is easily configurable via RS232/485 using Parker's C3 ServoManager™ software running on a PC or by downloading an existing configuration file from another T40 unit via the optional BDM keypad interface module. All setup is accomplished via intuitive drive configuration wizards and basic information of the application. Commissioning is even faster with the addition of software input simulation and auto-tuning. The CoDeSys IEC programming editor can also be launched directly from the C3 ServoManager software.

### Compax3 T40 Features

- 120 - 480 VAC power input range
- Continuous current output from 2.5 A (rms) to 155 A (rms)
- Resolver, encoder, high-resolution SinCos® or Stegmann Absolute rotary encoder feedback (single- or multi-turn) or Heidenhain Endat 2.1
- SSI encoder as a source for gearing, cam shapes and external position measurement
- Fully programmable IEC61131-3 single-axis drive/controller
- 6 programming formats to choose from – CFC, LD, FBD, SFC, ST and IL
- Electronic camming, electronic gearing functionality
- Wide selection of master sources supported
- Virtual master
- Registration input (800 ns capture speed)
- Programmable limit switches (PLS)
- Optional HEDA following bus
- Optional expansion I/O – 12 digital I/O points configurable as inputs or outputs, remote I/O with CANopen
- Optional fieldbus interfaces (CANopen, Profibus DP, DeviceNet and ETHERNET Powerlink)
- CE (EMC & LVD), UL and cUL

### Compax3 T40 Accessories

- Refer to the [Compax3 Accessories](#) section listed on page 15 of this catalog



# IEC61131-3 Programming Environment

IEC61131-3 is a manufacturer-independent programming environment for industrial automation devices. This programming interface brings tremendous flexibility to the user as well as worldwide recognition and support. The IEC61131-3 programmer may choose from five standard languages, both graphical and text-based, in order to develop the code for their application. Thus, users can program their device in the language or languages they are most comfortable with.

The graphical languages include:

- Ladder diagram (LD)
- Function block diagram (FBD)
- Continuous function chart (CFC)

The text-based languages include:

- Structured text (ST)
- Instruction list (IL)

An environment is also available for structuring program flow:

- Sequential function chart (SFC)

The standard IEC61131-3 programming language has gone beyond establishing itself in PLC systems in the last few years. Today it is also frequently used for PCs, SCADA systems and also motion control systems. The intelligent drive/controller versions of the Compax3 family use the IEC61131-3 interface to give users new levels of flexibility and power when developing their application.

## Motion Block Libraries for Compax3 T30 and T40

Parker makes IEC61131-3 programming for the Compax3 use even easier by providing motion-specific function block libraries, which are included with every Compax3 T30 and T40 product. These function block libraries allow users to insert pre-defined motion functions into their IEC project by selecting the desired function from a pull-down table, thus eliminating the need to program these functions manually. These libraries consist of function blocks created by both Parker and PLCopen™, a product- and company-independent organization that plays a significant role in supporting the IEC61131-3 programming language.

Some examples of the available Compax3 function modules include:

- Absolute motion
- Incremental (relative) motion
- Continuous motion

- Superimposed motion
- Homing
- Drive enable
- Stop motion
- Drive status / error clearing
- Ratio following
- Electronic cam selection
- Interchangeable force-position control block
- P.I.D. block (i.e., temp control)
- And dozens more!

## IEC61131-3 Features

- Five programming languages to choose from for ease of use
- Worldwide support for programming languages
- Program portability
- Multiple languages may be combined within a single project
- Minimal training and support effort
- Portability from one application project to another project
- IEC programming editor built into the standard C3 Servo Manager™ software

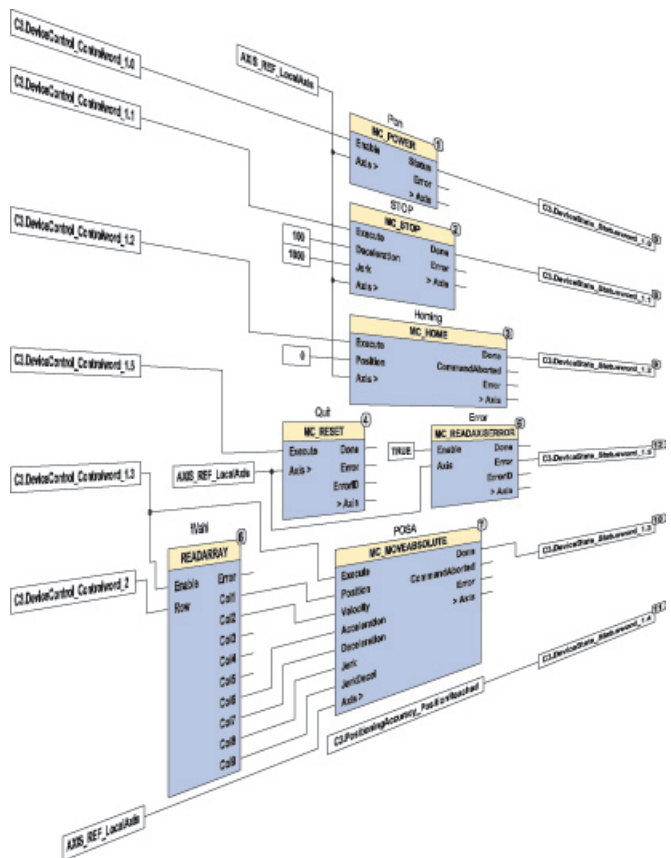

# Compax3 Software Tools

## C3 ServoManager™ Development Software

- User friendly, wizard-based drive configuration tool with navigation tree.
- Powerful online help system – accessible in any screen.
- MotorManager allows quick configuration of motors – automatically configures commutation settings.
- Multilingual support: English, German or French at the click of a button.
- C3 Profile Viewer – helps quantify S-curve acceleration.
- See Figure A.

Figure A

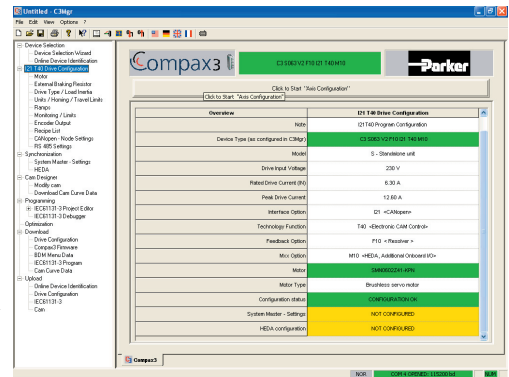

## C3 Optimization Tool

- Powerful system diagnostic and troubleshooting tool.
- Numerical and graphical status displays.
- Error display with fault history.
- Four-channel oscilloscope with ASCII and CSV export capability.
- Commissioning feature allows motor jogging, preset moves, homing, drive enable and more.
- Launched directly from within the C3 ServoManager development software.
- Auto-tuning
- Input simulation
- See Figure B.

Figure B

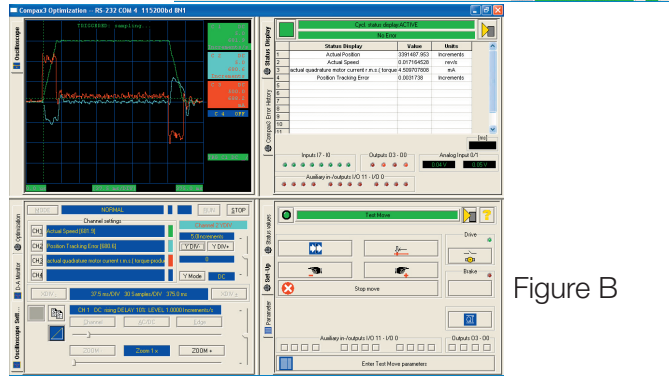

## IEC61131-3 Project Development Editor

- IEC61131-3 programming environment for Compax3 T30 and T40.
- Graphics editor for LD, CFC, SFC and FBD; text editor for IL and ST.
- Syntax coloring, multi-level undo/re-do and context-sensitive help.
- Library management for creating, accessing and selecting IEC function libraries.
- Launched directly from within the C3 ServoManager development software.
- See Figure C.

Figure C

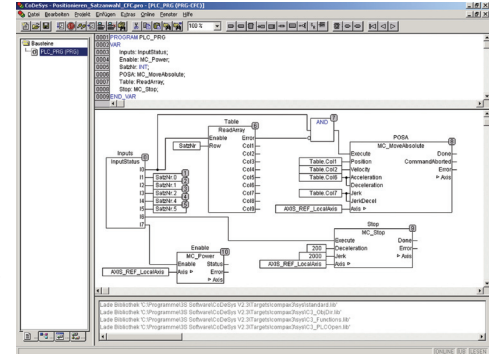

## IEC Debugger

- Diagnostic tool specifically tailored for monitoring IEC program execution.
- All object variables within the IEC program can be viewed and modified online.
- Debugger and Logic analyzer screens.
- Input-forcing within the IEC program.
- Launched directly from within the C3 ServoManager development software.
- See Figure D.

Figure D

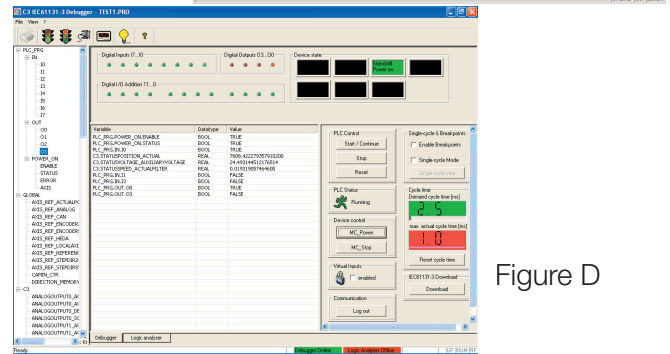

## C3 Cam Designer

- Graphical electronic cam creation tool for Compax3 T40 applications.
- Wide selection of curve interpolation types.
- Real-time generation of displacement diagrams.
- Launched directly from within the C3 ServoManager development software.
- See Figure E.

Figure E

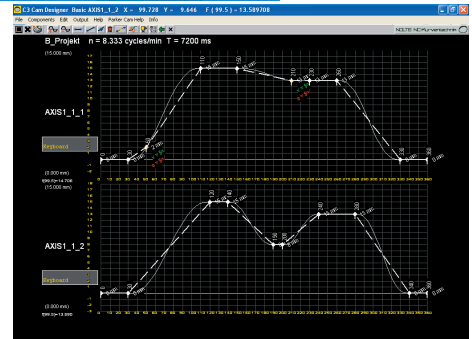

Compax3 Options

- Feedback
  - F10 Option
  - F11 Option
  - F12 Option
- Fieldbus
  - I20 Option
  - I21 Option
  - I22 Option
- Additional
  - I30 Option
  - M10 Option
  - M11 Option
  - M12 Option

Standard resolver feedback support,  
 Resolver position resolution: 19 bit; repeatability:  $\pm 0.005^\circ$   
 SinCos® position resolution: 21 bit; SinCos® (HiPerface™) high-resolution encoder support; absolute accuracy:  $\pm 0.002^\circ$ ; Stegmann  
 Quadrature rotary/linear encoder, sine-cosine linear, distance-coded encoder feedback support  
 Resolution, accuracy: dependent upon specification of encoder used; Endat 2.1 compatible feedback

Profibus - DPV0 (slave)  
 Transmission speed: up to 12Mbd  
 Available on T11, T30, T40 units

CANopen - DS402 (slave)  
 Transmission speed: selectable (up to 1Mbd)  
 Available on T11, T30, T40 units

DeviceNet slave available on T11, T30 and T40 units  
 Transmission speed: 125, 250, 500 kBits/second

ETHERNET Powerlink: Use I30 T11 with ACR9030/9040

HEDA following bus and additional onboard I/O (available on T11, T30 and T40 units)  
 HEDA:  
 Real-time following bus for line-shafting or multi-axis following applications  
 Configurable as master or slave; up to 19 units supported on network  
 Bus transmission speed: 10 Mbaud  
 Bus update rate: 500 microseconds (regardless of HEDA node count); 0.5  $\mu$ s jitter

Additional Onboard I/O:  
 12 I/O points, configurable as inputs or outputs in blocks of 4 (via software)  
 User-defined functionality for all points

HEDA following bus only (available on T30 and T40 units)  
 Additional onboard I/O only (available on I12 T11, IxxT30 and IxxT40 units)

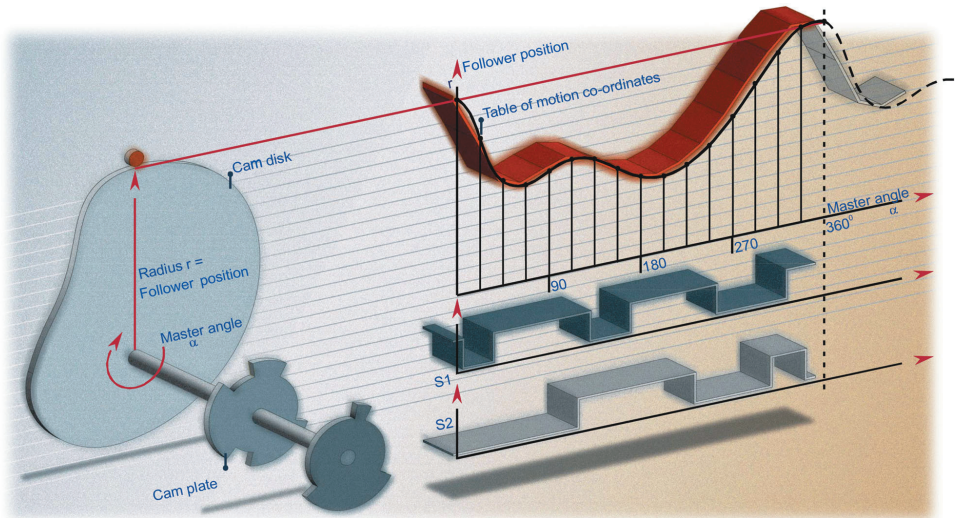



Compax3 S0XX V2 Specifications

Specifications

Drive Input Power

Voltage  
Phase  
Frequency  
24 VDC Logic Power (Required)

Drive Output Power

PWM

Continuous Current (RMS)

Peak Current (RMS)

Commutation

S025 V2

S063 V2

S100 V2

S150 V2

80-253 VAC	80-253 VAC	80-253 VAC	80-253 VAC
1Ø	1Ø	3Ø	3Ø
50/60 Hz	50/60 Hz	50/60 Hz	50/60 Hz
24 VDC ±15%	24 VDC ±15%	24 VDC ±15%	24 VDC ±15%
16/32 kHz (selectable)	16/32 kHz (selectable)	16/32 kHz (selectable)	8/16/32 kHz (selectable)
2.5 Amps	6.3 Amps	10 Amps	15 Amps
5 Amps	12.6 Amps	20 Amps	30 Amps
Sinusoidal	Sinusoidal	Sinusoidal	Sinusoidal

Performance

Torque Loop  
Velocity Loop  
Position Loop

62.5 micro seconds  
125 micro seconds  
125 micro seconds

Command Inputs (T10 only)

Velocity and Torque Mode  
Position Mode

14 bit, ±10 VDC Analog  
Step & Direction; 5V or 24 V level (300 kHz input frequency); differential signal

Onboard Digital Inputs

Type

Functions

1xx T10 (4 dedicated)  
1xx T11 (8 dedicated)  
1xx T30 (8 programmable\*)  
1xx T40 (8 programmable\*)

Sinking type, 24 V nom. @ 10 mA, high = 9-32 V, low <8 V

Drive stage enable, control input enable, reset, motor brake open/close  
Motion interrupt, Start, Drive Stage enable + 5 motion profile select inputs (or 4 inputs with a home input)  
User definable via IEC61131-3 programming environment  
User definable via IEC61131-3 programming environment

Analog Inputs (T11, T30, T40)

Two (dedicated); 14 bit

Onboard Digital Outputs

Type

Functions

1xx T10 (4 dedicated)  
1xx T11 (4 dedicated)  
1xx T30 (4 programmable\*)  
1xx T40 (4 programmable\*)

Encoder  
Relay

Sourcing type, rated for 24 V @ 100 mA, short-circuit protected

No fault, drive enabled, in position window, at zero point  
No fault, position reached, power stage active, at zero point  
User definable via IEC61131-3 programming environment  
User definable via IEC61131-3 programming environment  
Programmable up to 16,384 ppr (pre-quadrature)  
Normally closed, dry contact (switching current: 10-300 mA, switching voltage [AC/DC]: 100 mV-60 V)

Analog Outputs (T11, T30, T40)

Two (dedicated); 8 bit; software configurable as monitor outputs

Communications

Type

Baud Rate

Multi-drop (RS485)

Profibus\*\*

CANopen\*\*

DeviceNet\*\*

ETHERNET Powerlink\*\*

RS232 (3-wire) on RS485 (2- or 4-wire); 8-bit word length, 1 stop bit, no parity  
Fixed at 115.8 Kbaud for RS232; adjustable for RS485  
Up to 255 nodes  
DPV0 supported; selectable Baud rate, 12 Mbd maximum transmission speed  
DCiA, DS102 supported; selectable Baud rate, 1 Mbd maximum transmission speed  
Polled, C05/cyclic I/O and bit strobe; 500 kBit/second max speed  
Interplotted mask (ACR); fieldbus

Environmental

Temperature

Humidity

IP Class

Still air: 33-113°F (0-45°C); moving air: 33-122°F (0-50°C)  
0-75%, non-condensing  
IP 20

Protection

Short Circuit

Brownout

Over Voltage

Over Temperature

I<sup>2</sup>t

Safety Isolation

Phase-to-phase, phase-to-ground  
Below 70 VDC  
Will shut down when power dissipation capacity is exceeded  
Motor 330°F (170°C), Drive 221°F (105°C)  
Error generated if peak current > 3 seconds  
VDE0160

Standards

UL, cUL, CE (EMC), CE (LVD)

Internal Regeneration Capacities/Storable Energy

Compax3 S025 V2: 560 µF / 15Ws  
Compax3 S063 V2: 1120 µF / 30Ws  
Compax3 S100 V2: 780 µF / 21Ws  
Compax3 S150 V2: 1,170 µF / 31Ws

	S025	S063	S100	S150
H	191	191	248	248
W	84	100	115	158
D	172	172	172	172

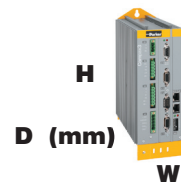

\* 12 additional I/O points available as an option  
\*\* Applicable only to models supporting this option

Compax3 SXXX V4 Specifications

Specifications

Drive Input Power

Voltage  
Phase  
Frequency  
24 VDC Logic Power (Required)

S038 V4

S075 V4

S150 V4

S300 V4

80-525 VAC	80-525 VAC	80-525 VAC	80-525 VAC
3Ø	3Ø	3Ø	3Ø
50/60 Hz	50/60 Hz	50/60 Hz	50/60 Hz
24 VDC ±15%	24 VDC ±15%	24 VDC ±15%	24 VDC ±15%

16/32 kHz (selectable)	16/32 kHz (selectable)	8/16/32 kHz (selectable)	8/16/32 kHz (selectable)
3.8 Amps	7.5 Amps	15 Amps	30 Amps
7.5 Amps	15 Amps	30 Amps	60 Amps
Sinusoidal	Sinusoidal	Sinusoidal	Sinusoidal

Drive Output Power

PWM  
Continuous Current (RMS)  
Peak Current (RMS)  
Commutation

Performance

Torque Loop  
Velocity Loop  
Position Loop

62.5 micro seconds  
125 micro seconds  
125 micro seconds

Command Inputs (T10 only)

Velocity and Torque Mode  
Position Mode

14 bit, ±10 VDC Analog  
Step & Direction; 5V or 24 V level (300 kHz input frequency); differential signal

Onboard Digital Inputs

Type  
Functions  
1xx T10 (4 dedicated)  
1xx T11 (8 dedicated)  
1xx T30 (8 programmable\*)  
1xx T40 (8 programmable\*)

Sinking type, 24 V nom. @ 10 mA, high = 9-32 V, low <8 V  
Drive stage enable, control input enable, reset, motor brake open/close  
Motion interrupt, Start, Drive Stage enable + 5 motion profile select inputs (or 4 inputs with a home input)  
User definable via IEC61131-3 programming environment  
User definable via IEC61131-3 programming environment

Analog Inputs (T11, T30, T40)

Two (dedicated); 14 bit

Onboard Digital Outputs

Type  
Functions  
1xx T10 (4 dedicated)  
1xx T11 (4 dedicated)  
1xx T30 (4 programmable\*)  
1xx T40 (4 programmable\*)

Sourcing type, rated for 24 V @ 100 mA, short-circuit protected  
No fault, drive enabled, in position window, at zero point  
No fault, position reached, power stage active, at zero point  
User definable via IEC61131-3 programming environment  
User definable via IEC61131-3 programming environment  
Programmable up to 16,384 ppr (pre-quadrature)  
Normally closed, dry contact (switching current: 10-300 mA, switching voltage [AC/DC]: 100 mV-60 V)

Encoder  
Relay

Analog Outputs (T11, T30, T40)

Two (dedicated); 8 bit; software configurable as monitor outputs

Communications

Type  
Baud Rate  
Multi-drop (RS485)  
Profibus\*\*  
ETHERNET Powerlink\*\*  
DeviceNet\*\*  
CANopen\*\*

RS232 (3-wire) on RS485 (2- or 4-wire); 8-bit word length, 1 stop bit, no parity  
Fixed at 115.8 Kbaud for RS232; adjustable for RS485  
Up to 255 nodes  
DPV0 supported; selectable Baud rate, 12 Mbd maximum transmission speed  
DCiA, DS102 supported; selectable Baud rate, 1 Mbd maximum transmission speed  
Polled, C05/cyclic I/O and bit strobe; 500 kBit/second max speed  
Interploated mask (ACR); fieldbus

Environmental

Temperature  
Humidity  
IP Class

Still air: 33-113°F (0-45°C); moving air: 33-122°F (0-50°C)  
0-75%, non-condensing  
IP 20

Protection

Short Circuit  
Brownout  
Over Voltage  
Over Temperature  
I<sup>2</sup>t  
Safety Isolation

Phase-to-phase, phase-to-ground  
Below 70 VDC  
Will shut down when power dissipation capacity is exceeded  
Motor 330°F (170°C), Drive 221°F (105°C)  
Error generated if peak current > 3 seconds  
VDE0160

Standards

UL, cUL, CE (EMC), CE (LVD)

Internal Regeneration Capacities/Storable Energy

Compax3 S038 V4: 235 µF / 37Ws  
Compax3 S075 V4: 470 µF / 75Ws  
Compax3 S150 V4: 690 µF / 110Ws  
Compax3 S300 V4: 1,100 µF / 176Ws

	S038	S075	S150	S300
H	248	248	248	380
W	100	115	158	175
D	172	172	172	172

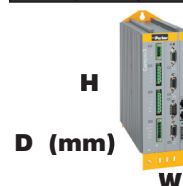

\* 12 additional I/O points available as an option  
\*\* Applicable only to models supporting this option

Compax3 HXXX V4 Specifications

Specifications

Drive Input Power

Voltage  
Phase  
Frequency  
24 VDC Logic Power (Required)

H050 V4

350-528 VAC  
3Ø  
50/60 Hz  
24 VDC ±15%

H090 V4

350-528 VAC  
3Ø  
50/60 Hz  
24 VDC ±15%

H125 V4

350-528 VAC  
3Ø  
50/60 Hz  
24 VDC ±15%

H155 V4

350-528 VAC  
3Ø  
50/60 Hz  
24 VDC ±15%

Drive Output Power

PWM  
Continuous Current (RMS)  
Peak Current (RMS)  
Commutation

8 kHz  
50 Amps @ 400 VAC  
75 Amps for 5 sec  
Sinusoidal

8 kHz  
90 Amps @ 400 VAC  
135 Amps for 5 sec  
Sinusoidal

8 kHz  
125 Amps @ 400 VAC  
187.5 Amps for 5 sec  
Sinusoidal

8 kHz  
155 Amps @ 400 VAC  
232.5 Amps for 5 sec  
Sinusoidal

Performance

Torque Loop  
Velocity Loop  
Position Loop

62.5 micro seconds  
125 micro seconds  
125 micro seconds

Command Inputs (T10 only)

Velocity and Torque Mode  
Position Mode

14 bit, ±10 VDC Analog  
Step & Direction; 5V or 24 V level (300 kHz input frequency); differential signal

Onboard Digital Inputs

Type  
Functions  
1xx T10 (4 dedicated)  
1xx T11 (8 dedicated)  
1xx T30 (8 programmable\*)  
1xx T40 (8 programmable\*)

Sinking type, 24 V nom. @ 10 mA, high = 9-32 V, low <8 V  
Drive stage enable, control input enable, reset, motor brake open/close  
Motion interrupt, Start, Drive Stage enable + 5 motion profile select inputs (or 4 inputs with a home input)  
User definable via IEC61131-3 programming environment  
User definable via IEC61131-3 programming environment

Analog Inputs (T11, T30, T40)

Two (dedicated); 14 bit

Onboard Digital Outputs

Type  
Functions  
1xx T10 (4 dedicated)  
1xx T11 (4 dedicated)  
1xx T30 (4 programmable\*)  
1xx T40 (4 programmable\*)  
Encoder  
Relay

Sourcing type, rated for 24 V @ 100 mA, short-circuit protected  
No fault, drive enabled, in position window, at zero point  
No fault, position reached, power stage active, at zero point  
User definable via IEC61131-3 programming environment  
User definable via IEC61131-3 programming environment  
Programmable up to 16,384 ppr (pre-quadrature)  
Normally closed, dry contact (switching current: 10-300 mA, switching voltage [AC/DC]: 100 mV-60 V)

Analog Outputs (T11, T30, T40)

Two (dedicated); 8 bit; software configurable as monitor outputs

Communications

Type  
Baud Rate  
Multi-drop (RS485)  
Profibus\*\*  
CANopen\*\*  
DeviceNet\*\*  
ETHERNET Powerlink\*\*

RS232 (3-wire) on RS485 (2- or 4-wire); 8-bit word length, 1 stop bit, no parity  
Fixed at 115.8 Kbaud for RS232; adjustable for RS485  
Up to 255 nodes  
DPV0 supported; selectable Baud rate, 12 Mbd maximum transmission speed  
DCiA, DS102 supported; selectable Baud rate, 1 Mbd maximum transmission speed  
Polled, C05/cyclic I/O and bit strobe; 500 kBit/second max speed  
Interploated mask (ACR); fieldbus

Environmental

Temperature  
Humidity  
IP Class

Still air: 33-113°F (0-45°C); moving air: 33-122°F (0-50°C)  
0-75%, non-condensing  
IP 20

Protection

Short Circuit  
Brownout  
Over Voltage  
Over Temperature  
I<sup>2</sup>t  
Safety Isolation

Phase-to-phase, phase-to-ground  
Below 70 VDC  
Will shut down when power dissipation capacity is exceeded  
Motor 330°F (170°C), Drive 221°F (105°C)  
Error generated if peak current > 3 seconds  
VDE0160

Standards

UL, cUL, CE (EMC), CE (LVD)

Internal Regeneration Capacities/Storable Energy

Compax3 H050 V4: 2600 µF / 602Ws  
Compax3 H090 V4: 3150 µF / 729Ws  
Compax3 H125 V4: 5000 µF / 1158Ws  
Compax3 H155 V4: 5000 µF / 1158Ws

	H050	H090	H125	H155
H	453	668.6	720	720
W	252	257	257	257
D	245	312	355	355

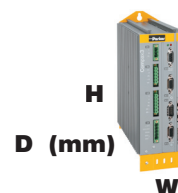

\* 12 additional I/O points available as an option  
\*\* Applicable only to models supporting this option

Compax3 M Specifications

Specifications

**Drive Input Power**  
 Voltage  
 Phase  
 Frequency  
 24 VDC Logic Power (Required)  
**Drive Output Power**  
 PWM  
 Continuous Current (RMS)  
 Peak Current (RMS)  
 Commutation

	Power Supply Units		Axis Units			
	MP10 D6	MP20 D6***	M050 D6	M100 D6	M150 D6	M300 D6***
240/480 VAC	240/480 VAC	240/480 VAC	680 VDC	680 VDC	680 VDC	680 VDC
3-Ø	3-Ø	3-Ø	DC Bus	DC Bus	DC Bus	DC Bus
50/60 Hz	50/60 Hz	50/60 Hz	Bussed 24 VDC	Bussed 24 VDC	Bussed 24 VDC	Bussed 24 VDC
24 VDC	24 VDC	24 VDC				
NA	NA	NA	8/16/32 kHz	8/16/32 kHz	8/16/32 kHz	8/16/32 kHz
15A @ 480 VAC	30A @ 480 VAC	30A @ 480 VAC	4A @ 480 VAC	8A @ 480 VAC	12.5A @ 480 VAC	24A @ 480 VAC
30A @ 480 VAC	60A @ 480 VAC	60A @ 480 VAC	8A @ 480 VAC	16A @ 480 VAC	25A @ 480 VAC	48A @ 480 VAC
NA	NA	NA	Sinusoidal	Sinusoidal	Sinusoidal	Sinusoidal

**Performance**  
 Torque Loop  
 Velocity Loop  
 Position Loop

62.5 micro seconds  
 125 micro seconds  
 125 micro seconds

**Command Inputs (T10 only)**  
 Velocity and Torque Mode  
 Position Mode

14 bit, ±10 VDC Analog  
 Step & Direction; 5V or 24 V level (300 kHz input frequency); differential signal

**Onboard Digital Inputs**  
 Type  
 Functions

1xx T10 (4 dedicated)  
 1xx T11 (8 dedicated)  
 1xx T30 (8 programmable\*)  
 1xx T40 (8 programmable\*)

Sinking type, 24 V nom. @ 10 mA, high = 9-32 V, low <8 V  
 Drive stage enable, control input enable, reset, motor brake open/close  
 Motion interrupt, Start, Drive Stage enable + 5 motion profile select inputs (or 4 inputs with a home input)  
 User definable via IEC61131-3 programming environment  
 User definable via IEC61131-3 programming environment

**Analog Inputs (T11, T30, T40)**

Two (dedicated); 14 bit

**Onboard Digital Outputs**  
 Type  
 Functions

1xx T10 (4 dedicated)  
 1xx T11 (4 dedicated)  
 1xx T30 (4 programmable\*)  
 1xx T40 (4 programmable\*)

Encoder  
 Relay

Sourcing type, rated for 24 V @ 100 mA, short-circuit protected  
 No fault, drive enabled, in position window, at zero point  
 No fault, position reached, power stage active, at zero point  
 User definable via IEC61131-3 programming environment  
 User definable via IEC61131-3 programming environment  
 Programmable up to 16,384 ppr (pre-quadrature)  
 Normally closed, dry contact (switching current: 10-300 mA, switching voltage [AC/DC]: 100 mV-60 V)

**Analog Outputs (T11, T30, T40)**

Two (dedicated); 8 bit; software configurable as monitor outputs

**Communications**

Type  
 Baud Rate  
 Multi-drop (RS485)  
 Profibus\*\*  
 CANopen\*\*  
 DeviceNet\*\*  
 ETHERNET Powerlink\*\*

RS232 (3-wire) on RS485 (2- or 4-wire); 8-bit word length, 1 stop bit, no parity  
 Fixed at 115.8 Kbaud for RS232; adjustable for RS485  
 Up to 255 nodes  
 DPV0 supported; selectable Baud rate, 12 Mbd maximum transmission speed  
 DCiA, DS102 supported; selectable Baud rate, 1 Mbd maximum transmission speed  
 Polled, C05/cyclic I/O and bit strobe; 500 kBit/second max speed  
 Interploated mask (ACR); fieldbus

**Environmental**

Temperature  
 Humidity  
 IP Class

Still air: 33-113°F (0-45°C); moving air: 33-122°F (0-50°C)  
 0-75%, non-condensing  
 IP 20

**Protection**

Short Circuit  
 Brownout  
 Over Voltage  
 Over Temperature  
 I<sup>2</sup>t  
 Safety Isolation

Phase-to-phase, phase-to-ground  
 Below 70 VDC  
 Will shut down when power dissipation capacity is exceeded  
 Motor 330°F (170°C), Drive 221°F (105°C)  
 Error generated if peak current > 3 seconds  
 VDE0160

**Standards**

UL, cUL, CE (EMC), CE (LVD)

**Internal Regeneration Capacities/Storable Energy**

Compax3 M050 V6: 110 µF / 10Ws @ 480 Volts  
 Compax3 M100 V6: 220 µF / 21Ws @ 480 Volts  
 Compax3 M150 V6: 220 µF / 21Ws @ 480 Volts

	MP10	MP20	M050, M100 M1050	M300
H	360	360	360	360
W	50	100	50	100
D	263*	263*	263*	263*

\* Depth can be reduced to 190mm (7.5") with feed-through mounting.

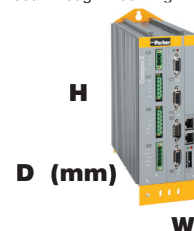

\* 12 additional I/O points available as an option  
 \*\* Applicable only to models supporting this option  
 \*\*\* To be released in Fall 2008

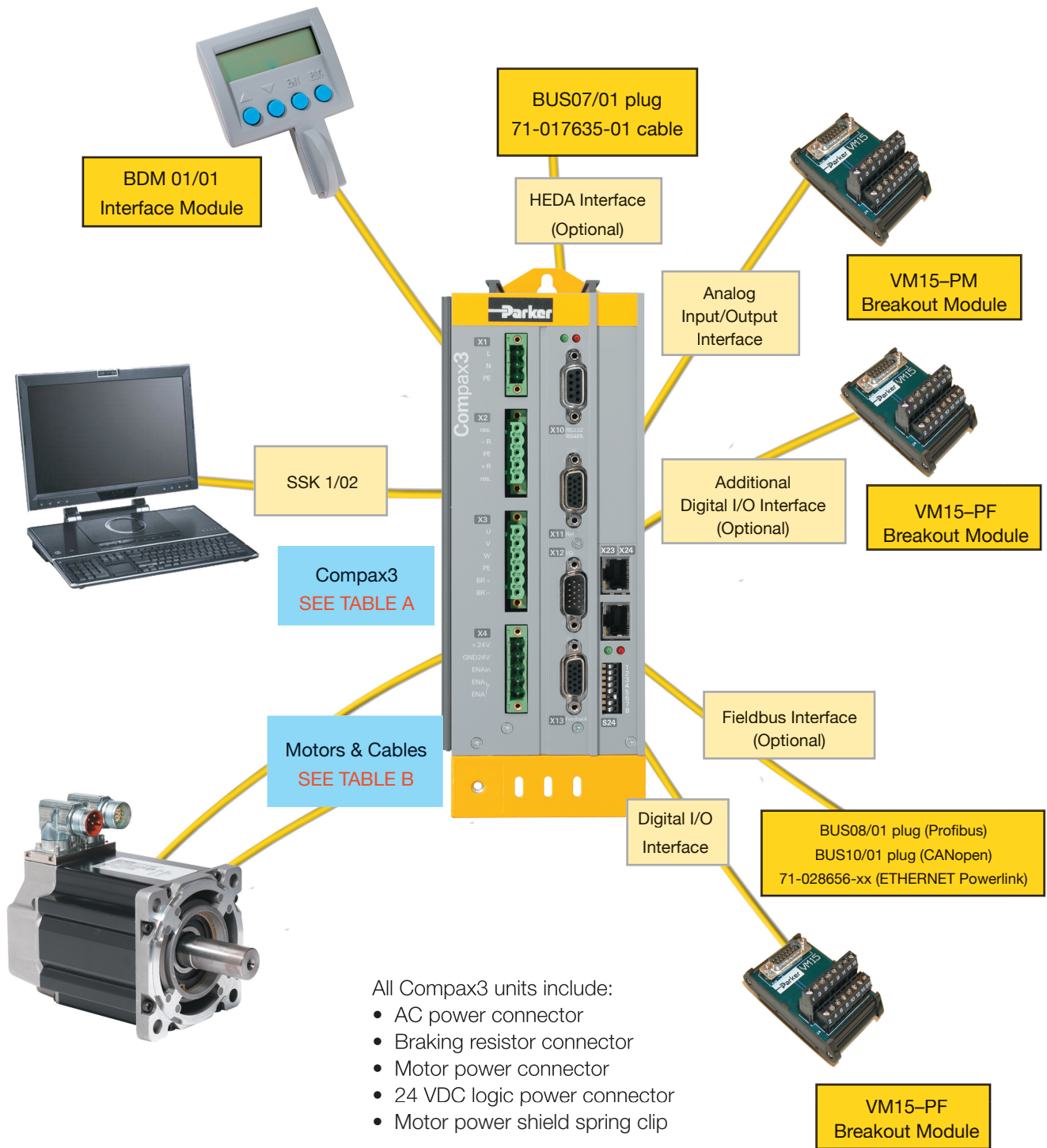

Connector

X11 Analog I/O, step-and-direction input, aux encoder	VM15-PM
X12 Digital I/O	VM15-PF
X13 Feedback	VM15-PM
X22 Expansion I/O	VM15-PF

For a complete list of [Compax3 Accessories](#), please refer to page 15

## Ordering a Compax3 System

**Table A – Compax3 Order Code**

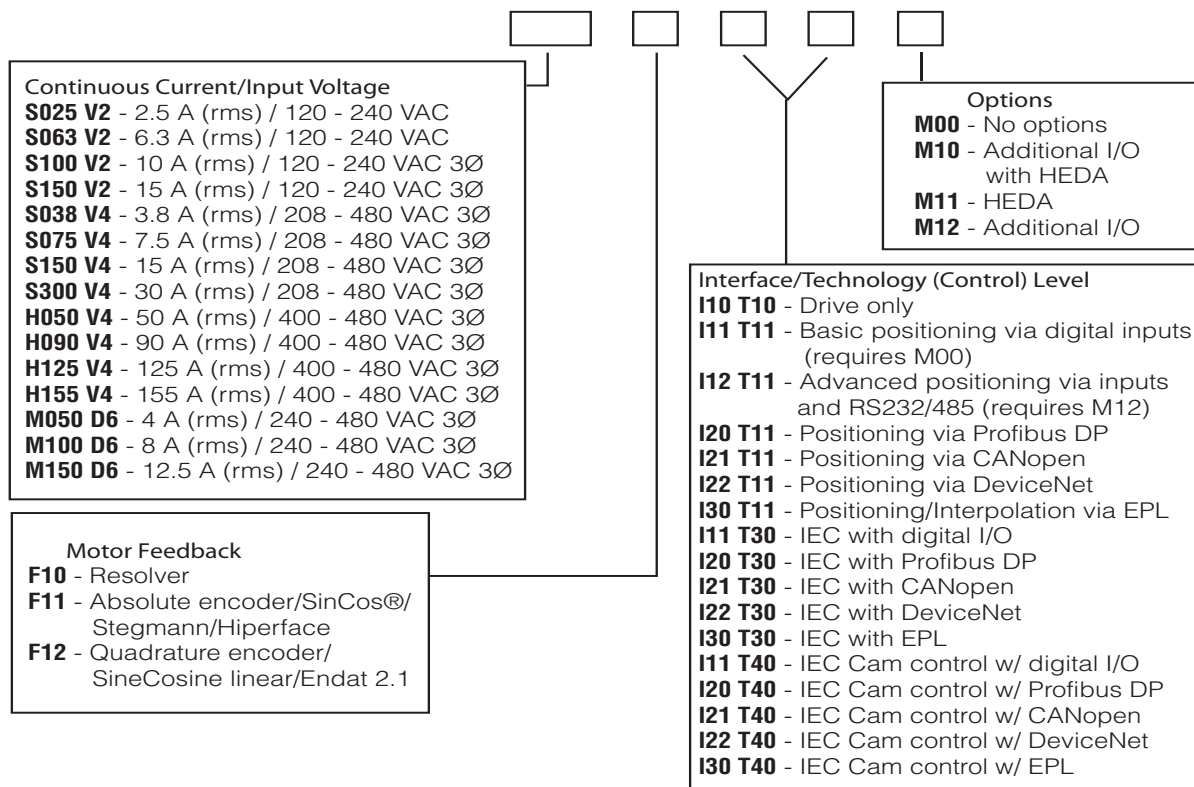

**Table B – Servo Motor Power/Feedback Cables – As Easy As 1-2-3!**

Compax3 PS Motor-Drive Cables

PS Feedback Cables			PS Motor Power Cables		
1. Choose Your Feedback Type	2. Choose Your Motor Family	3. Your Part Number is:	1. Choose Your Motor Current	2. Choose Your Motor Family	3. Your Part Number is:
Resolver	<ul style="list-style-type: none"> <li>BE 23, 34</li> <li>NeoMetric/ J Series 34, 70, 92</li> <li>MaxPlus 72 - 190</li> <li>M Series 105 - 205</li> <li>SMN 60 - 142</li> <li>MaxPlusPlus (MPP)</li> </ul>	<b>F-2B1-xx</b>	Up to 6A RMS continuous (240VAC only)	<ul style="list-style-type: none"> <li>BE 23</li> <li>NeoMetric, J Series</li> <li>MaxPlusPlus (MPP)</li> </ul>	<b>P-1A1-xx</b>
SinCos/Stegmann/Hiperface	<ul style="list-style-type: none"> <li>BE 34</li> <li>NeoMetric/ J Series 34, 70, 92</li> <li>MaxPlus 72 - 190</li> <li>M Series 105 - 205</li> <li>SMN 60 - 142</li> <li>MaxPlusPlus (MPP)</li> </ul>	<b>F-2B1-xx</b>	Up to 20A RMS continuous (240 or 480V)	<ul style="list-style-type: none"> <li>BE 34</li> <li>NeoMetric, J Series</li> <li>MaxPlus</li> <li>M Series</li> <li>SMN Series</li> <li>MaxPlusPlus (MPP)</li> </ul>	<b>P-3B1-xx</b>
Encoder	<ul style="list-style-type: none"> <li>BE 23, 34</li> <li>NeoMetric/ J Series 34, 70, 92</li> <li>MaxPlus 72 - 190</li> <li>M Series 105 - 205</li> <li>SMN 60 - 142</li> <li>MaxPlusPlus (MPP)</li> </ul>	<b>F-2C1-xx</b>	20A to 30A RMS (240 or 480V)	<ul style="list-style-type: none"> <li>M Series</li> <li>MaxPlusPlus (MPP)</li> </ul>	<b>P-4B1-xx</b>
			20A to 30A RMS (240 or 480V)	<ul style="list-style-type: none"> <li>M Series</li> <li>MaxPlus</li> <li>MaxPlusPlus (MPP)</li> </ul>	<b>P-4B2-xx</b>
			30A to 50A RMS (240 or 480V)	<ul style="list-style-type: none"> <li>M Series</li> <li>MaxPlus</li> <li>MaxPlusPlus (MPP)</li> </ul>	<b>P-6B2-xx</b>
			> 50A RMS	Contact factory	<b>Custom product</b>

-XX denotes cable length in feet; motor power and feedback cables available in standard lengths of 10, 25 and 50 feet (other lengths also available).

Compax3 Accessories

Part Number	Product Description
<b>Power Supply**</b> C3MP10USBM000 C3MP20USBM000	10kW power supply for Compax3M axis units; 240/480 3-phase 20kW power supply for Compax3M axis units; 240/480 3-phase
<b>Breakout Modules</b> VM15-PM VM15-PF VM15-PM-05 VM15-PF-05 VM15-PM-10 VM15-PF-10	15-pin breakout module and 2' cable to Compax3 feedback or analog encoder 15-pin breakout module and 2' cable to Compax3 digital I/O 15-pin breakout module and 5' cable to Compax3 feedback or analog encoder 15-pin breakout module and 5' cable to Compax3 digital I/O 15-pin breakout module and 10' cable to Compax3 feedback or analog encoder 15-pin breakout module and 10' cable to Compax3 digital I/O
<b>Connector Kits</b> ZBH02/01 ZBH02/02 ZBH02/03 ZBH04/01 ZBH04/02 ZBH04/03	Replacement connector kit for Compax3 S025 V2, S063 V2 products Replacement connector kit for Compax3 S038 V4, S075 V4, S150 V4 products Replacement connector kit for Compax3 S300 V4 products Replacement connector kit for Compax3 M050D6, M100D6, M150D6 Replacement connector kit for Compax3 M300D6 Replacement connector kit for Compax3 MP10D6 and MP20D6 (power supply)
<b>Communication Cable</b> SSK1/02 SSK32/20 VBK17/01	8' cable, RS232 serial communication cable (PC to Compax3) Communications dongle for C3Hxxx; one unit ships with drive - replacement only X10 to X10 jumper - replacement only for C3H
<b>Braking Resistors</b> BRM08/01 BRM05/01 BRM05/02 BRM04/01 BRM04/02 BRM04/03 BRM09/01 BRM10/01 BRM11/01 BRM12/01 BRM13/01 BRM14/01	Braking resistor for Compax3 S025, S038 units (60 W continuous, 250 W peak) Braking resistor for Compax3 S063, S075 units (180 W continuous, 2300 W peak) Braking resistor for Compax3 S150 units (570 W continuous, 6900 W peak) Braking resistor for Compax3 S300 units (570 W continuous, 6900 W peak) Braking resistor for Compax3 S300 units (740 W continuous, 8900 W peak) Braking resistor for Compax3 S300 and MP20D6 units (1500 W continuous, 18000 W peak) Braking resistor for Compax3 S100 units (570 W continuous, 6900 W peak) Braking resistor for Compax3 S150V4 units (570 W continuous, 6900 W peak) Braking resistor for Compax3 H0xx units (3500 W continuous, 19.3 kW peak) Braking resistor for Compax3 H1xx units (4500 W continuous, 24.8 kW peak) Braking resistor for Compax3 MP10D6 (500 W continuous) Braking resistor for Compax3 MP20D6 (500 W continuous, two 15ohm in series)
<b>EMC Accessories</b> MDR01/04 MDR01/01 MDR01/02 NFI01/01 NFI01/02 NFI01/03 NFI02/01 NFI02/02 NFI02/03 NFI03/01 NFI03/02	Compax3 motor output filter (rated up to 6.3 A continuous current motors) Compax3 motor output filter (rated up to 16 A continuous current motors) Compax3 motor output filter (rated up to 30 A continuous current motors) Mains Filter* for Compax3 S025, S063 units Mains Filter* for Compax3 S038, S075, S150 units Mains Filter* for Compax3 S300 units Mains Filter* for Compax3, 50A Mains Filter* for Compax3, 90A Mains Filter* for Compax3, 125A & 155A Mains Filter* for Compax3, 25A for C3MP10D6 power supply Mains Filter* for Compax3, 25A for C3MP20D6 power supply
<b>Fieldbus &amp; HEDA Accessories</b> 71-028856-xx 71-017835-01 BUS07/01 BUS08/01 BUS10/01	Shielded ETHERNET Powerlink cable (from ACR to Compax3/Aries) 5' cable, HEDA bus cable HEDA bus termination plug AND termination for C3M axis module communication bus Profibus cable connector with integral bus terminal switch (plug only) CANopen cable connector with integral bus terminal switch (plug only)
<b>Compax3 I10 T10 Drive Command Cables</b> 71-021625-XX 71-021108-XX	Compax3 I10 T10 drive-to-6K analog command cable (torque, velocity mode only) Compax3 I10 T10 drive-to-ACR analog command cable (torque, velocity mode only)

-XX denotes cable length in feet; available in 4' and 10' lengths.

\* For Class A (EMC) compliance for commercial or residential applications where motor cable lengths exceed 33 feet (10 m).

\*\* Required for C3M; not used for C3S/H.

BDM01/01

Compax3 diagnostic interface module

The BDM01/01 is a palm-sized, transportable diagnostic module that can be used to transmit drive configuration data to/from multiple Compax3 units, without the need for using a PC. BDM01/01 features include:

- Upload/download transfer of drive configuration files to other Compax3 units\*
- Online display of drive, error status
- Online modification of drive parameters, such as error reset, jogging, motor brake open/close, tuning gains, etc.\*\*
- Plugs into RS232 port; hot-swappable
- Multi-language capable – English, German, French
- Modification of up to 15 user-defined program variables when used with Compax3 T30 or T40 units

\* Identical control level

\*\* Features depend on control level

Compax3 System Architecture

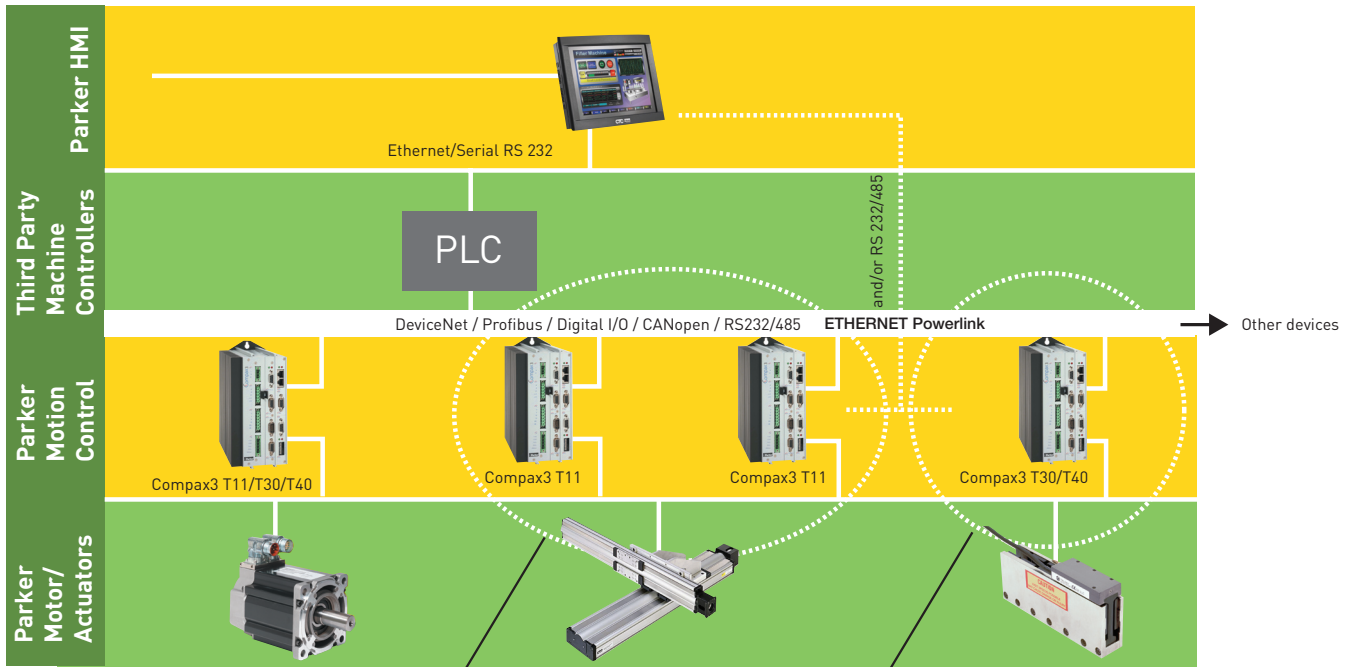

- T11**
1. Fast, Easy Setup - No code to learn
  2. 31 unique motion profiles
  3. PLC maintains all motion control execution, conditional, and math tasks
  4. Requires external logic to make all control decisions

- T30/T40**
1. Simple to Complex Motion
  2. Fully programmable, IEC61131-3 controller
    - Access to all internal data/status registers (i.e., current, velocity)
    - Make motion-related decisions based on values and conditions
  3. Stand-alone or PLC controlled
  4. Fully programmable and expandable I/O

Online Training

The screenshot shows a stack of training video boxes for models 110T10, 111T11, 112T11, and 111T30. Below them is a screenshot of the website [parkermotion.com](http://parkermotion.com) with a search bar containing "training video" and a search button. The website interface shows various product and technical information.

**Compax3 Video Training Series**  
 Short, Easy-to-understand, step-by-step video tutorials for:

- 1) Software navigation
- 2) Drive selection
- 3) Drive commissioning
- 4) Motion profile configuration
- 5) Making motion
- 6) Oscilloscope and optimization